

AutoCAD 2017 Preview Guide



Keep moving forward with the new features in Autodesk® AutoCAD® 2017 software. Create stunning designs and improve collaboration with innovative productivity tools. Manage all of your software updates with ease using the Autodesk® desktop app. With just two clicks, you can share your drawing views with collaborators by publishing them to the cloud. Import the geometry from a PDF file into your drawing as an AutoCAD object, and utilize powerful new tools to create and edit centerlines and center marks. And you can take the power of AutoCAD with you wherever you go with an easy-to-use mobile app.

Table of contents

- Simplified 3
 - License Manager 3
 - User interface..... 4
 - Associative centerlines and center marks 21
- Personalized 23
 - Smooth migration 23
 - Autodesk desktop app 25
- Connected 27
 - Importing PDF files..... 27
 - A360 31
 - 3D printing 34
 - Coordination model object snap 36
- Innovative 36
 - Graphics 36

Simplified

License Manager

AutoCAD 2017 introduces a new License Manager, making it easier to change between license types and save your work when a network license loses connection with the License Manager.

You no longer choose your license type and enter a serial number during the install process. Instead, you select it when you first launch AutoCAD. You choose between a serial number (stand-alone) and a network license.

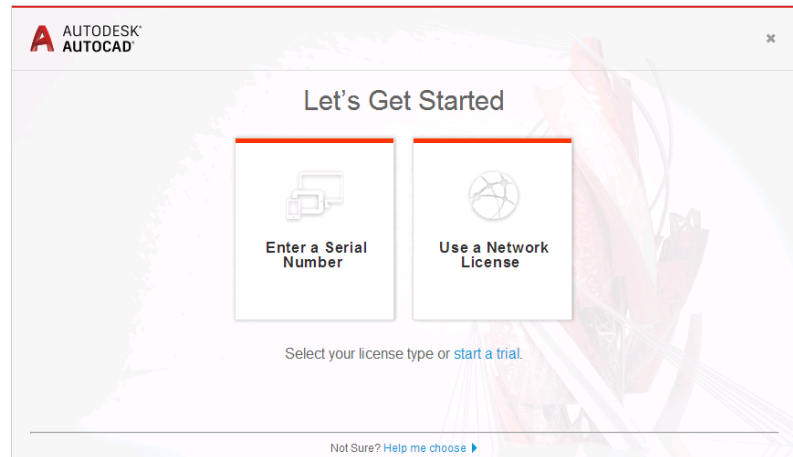

A new option in the Infocenter menu provides access to the License Manager, where you can view information about the software license and well as installed plug-ins, add-ons, and extensions. You can also change the type of license. For example, you can change from a network license or stand-alone (serial number) to another license type.

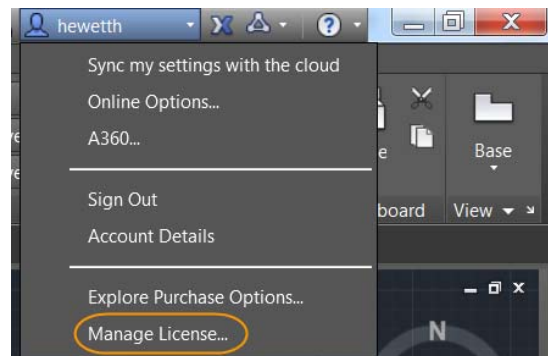

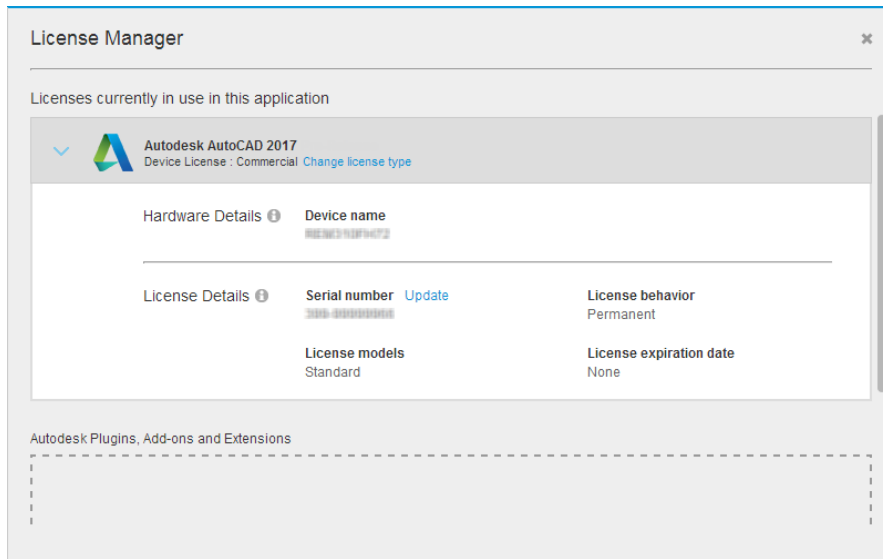

If you are using a network license and you lose your connection to the license server, a message is displayed indicating that the connection was lost. In the message, you can choose to have AutoCAD save your drawings and then shut down, or while time is still available, you can go back to AutoCAD to manually save your work. The timer to automatically shut down AutoCAD doesn't start until you dismiss the message.

User interface

Dialog box enhancements

AutoCAD 2017 addresses the #3 AUGI wishlist request by increasing the default size of some dialog boxes and enabling you to resize others while maintaining their size the next time you launch AutoCAD. With these enhancements, you can view more information with less scrolling. In addition, unnecessary tools and tooltips have been removed from the scrolling window of several dialog boxes.

Select File – Access the Select File dialog box from nearly any tool that enables you to select files, including New, Open, Save, and Save As, just to name a few.



The size of the preview pane in the Select File dialog box is increased, and the link to Autodesk® Buzzsaw® software as a service (SaaS) in the Places list is removed.

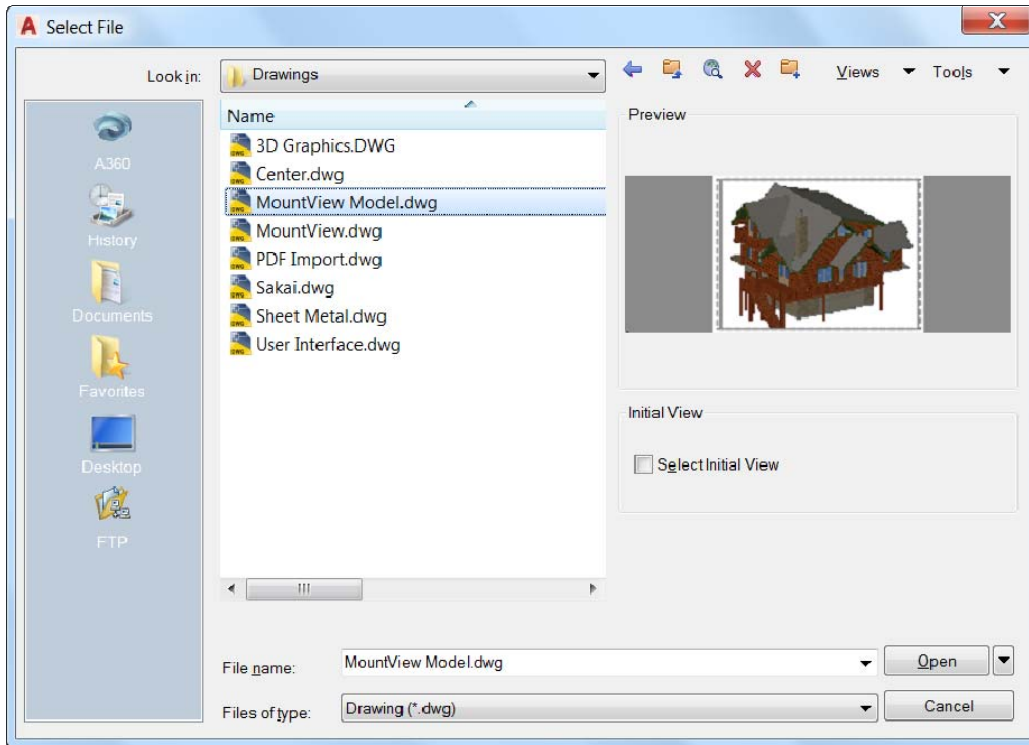

Insert – Access the Insert dialog box from the Insert panel of the Insert ribbon tab. When you click Insert, the Gallery view displays the available blocks by default. To display the Insert dialog box, you can click More Options or set GALLERYVIEW to 0 (off).

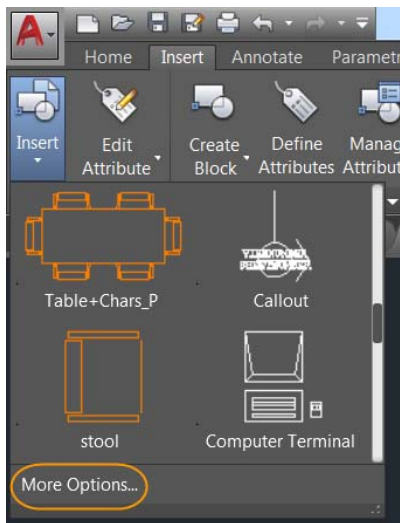

The Insert dialog box is enlarged and reorganized to display a larger preview image and more characters in the Name field. You can resize the Insert dialog box to display larger preview images.

The Name field now supports AutoComplete. As you begin typing a block name, it automatically fills in the rest of the name, minimizing the need for you to scroll through the block list.

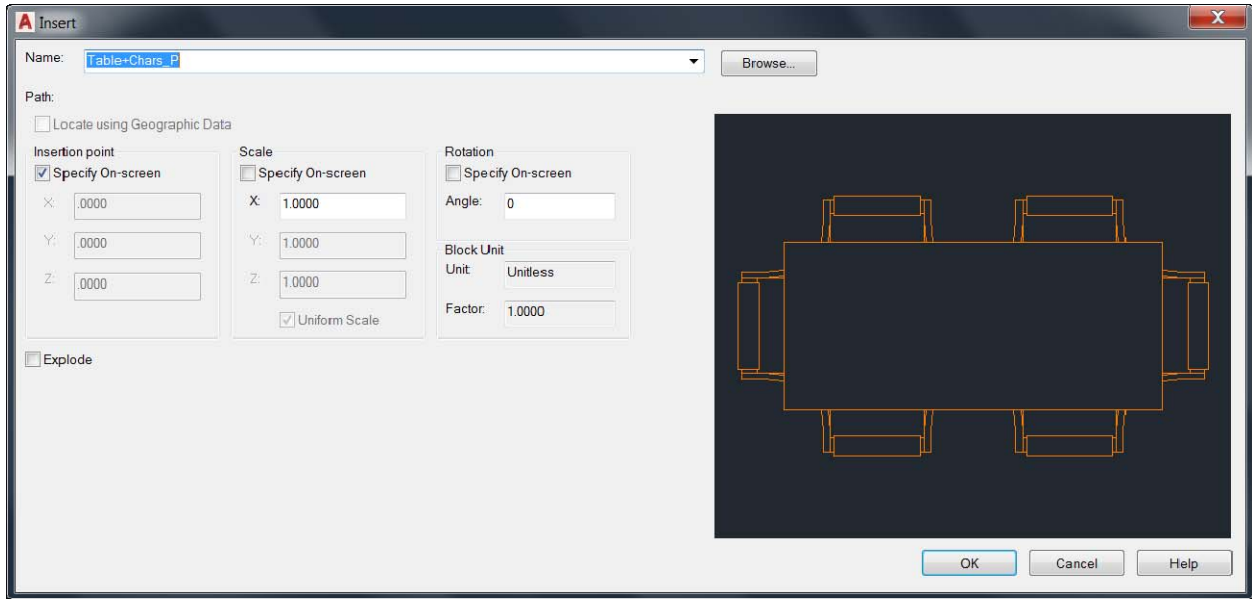

Page Setup Manager – Access the Page Setup Manager by right-clicking a layout tab.

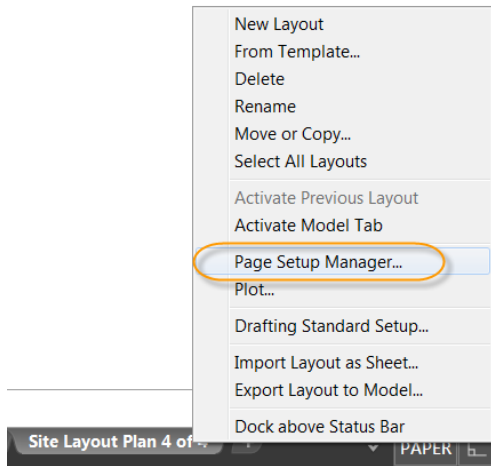

You can increase the height of the Page Setup Manager in addition to the width to display more page setups at one time.

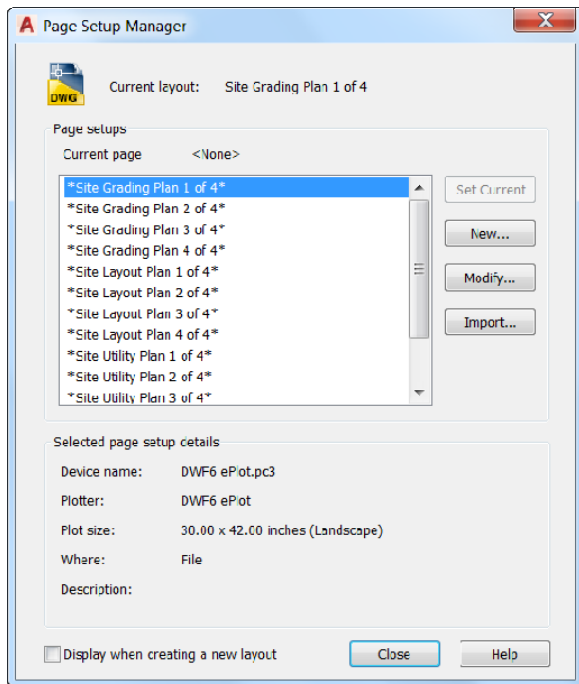

Object Grouping – Access the Object Grouping dialog box from the Group panel of the Home ribbon tab.

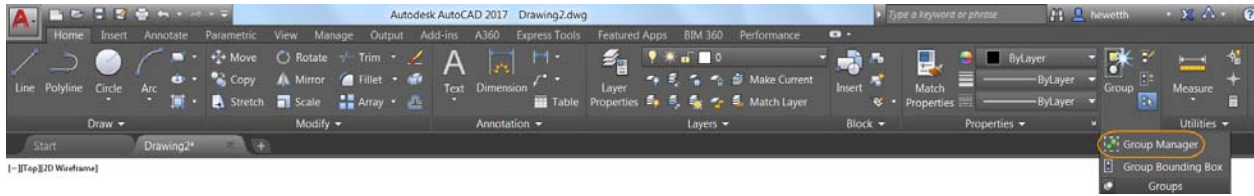

The height of the Object Grouping dialog box is increased. It now displays 17 groups at one time, compared to 11 groups in previous releases.

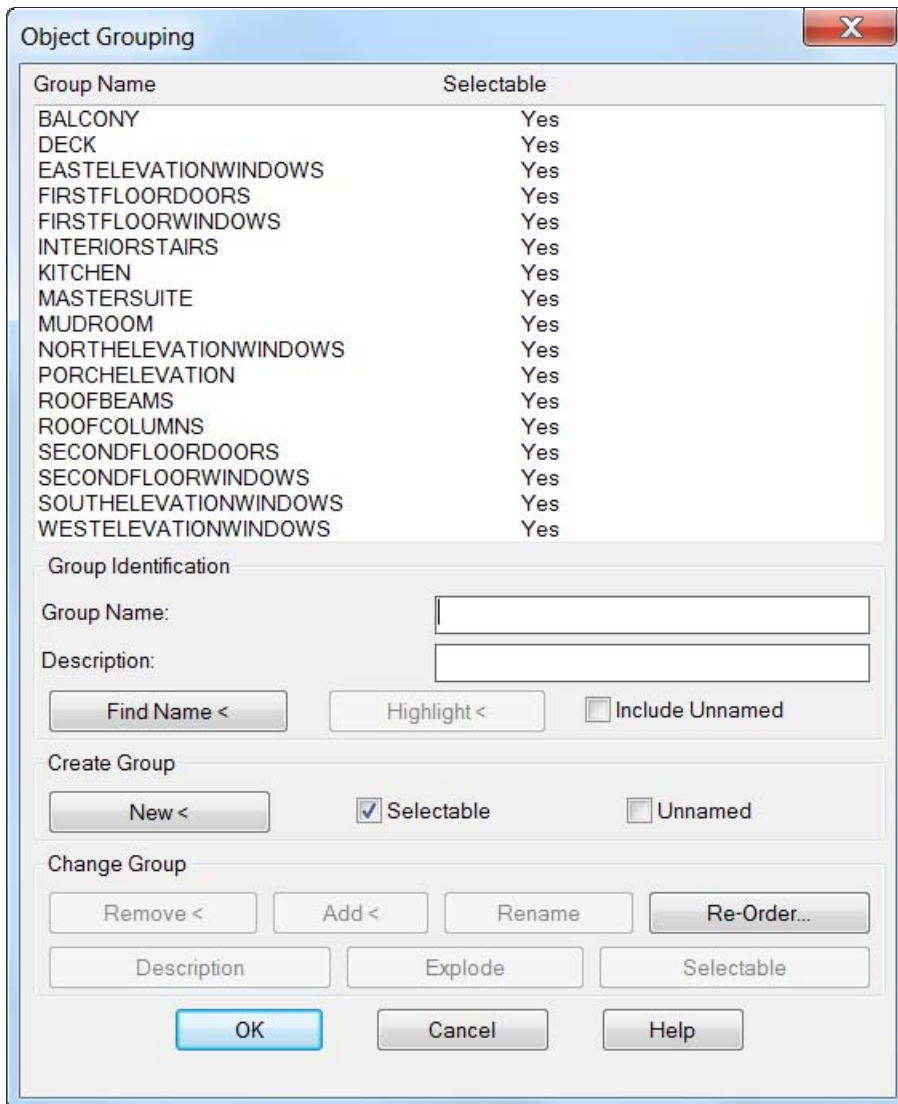

Layer States Manager – Access the Layer States Manager from the Layers panel of the Home ribbon tab.

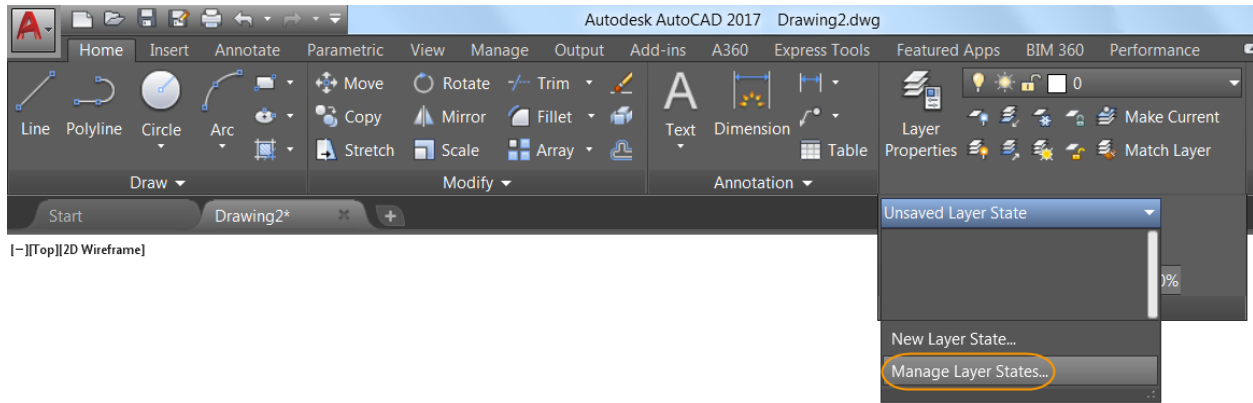

You can increase the size of the Layer States Manager to display more layer state information at one time.

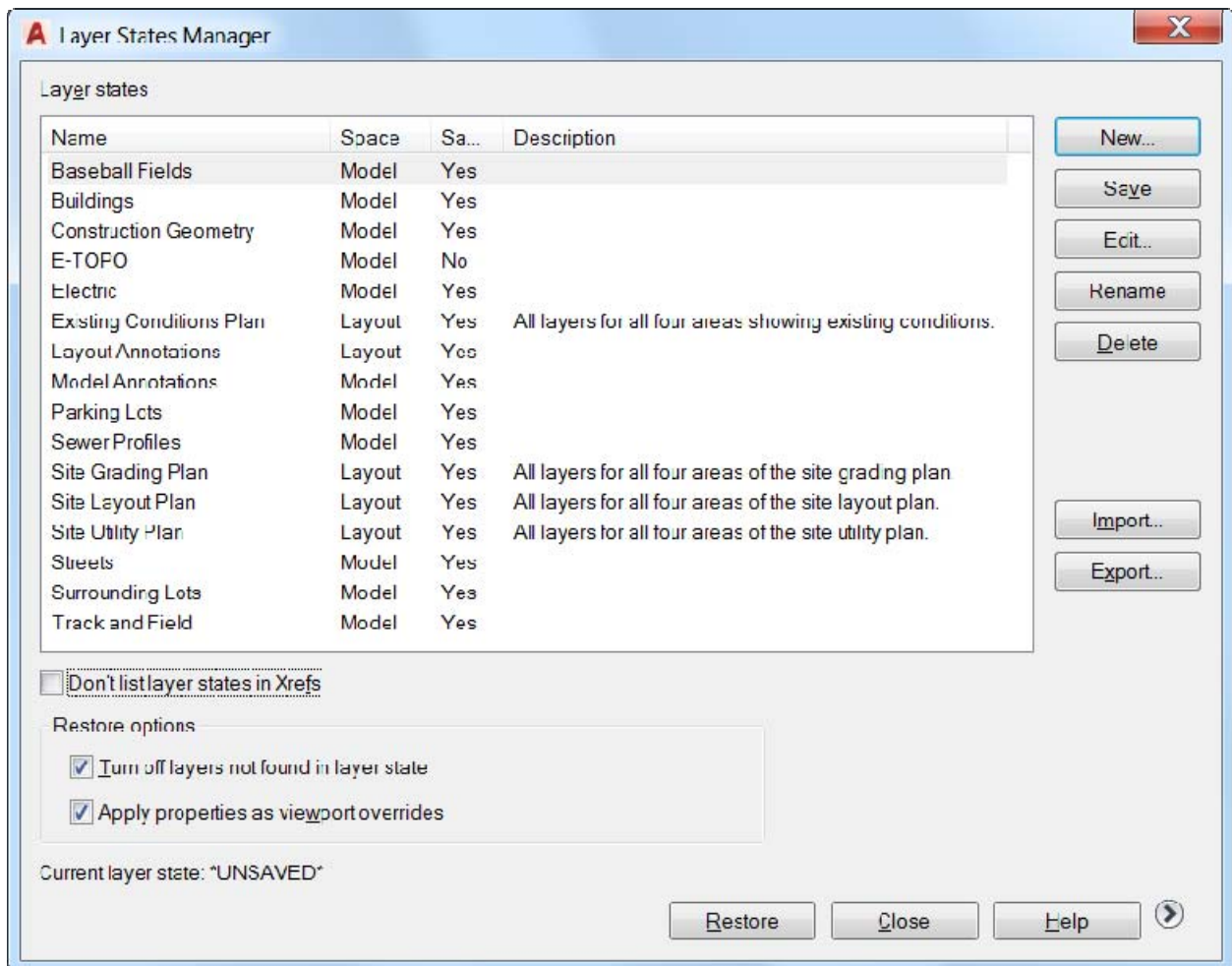

Edit Attributes – Access the Edit Attributes dialog box with the ATTEDIT command.

The height of the Edit Attributes dialog box is increased. It now displays 15 attributes at one time, compared to 8 attributes in previous releases.

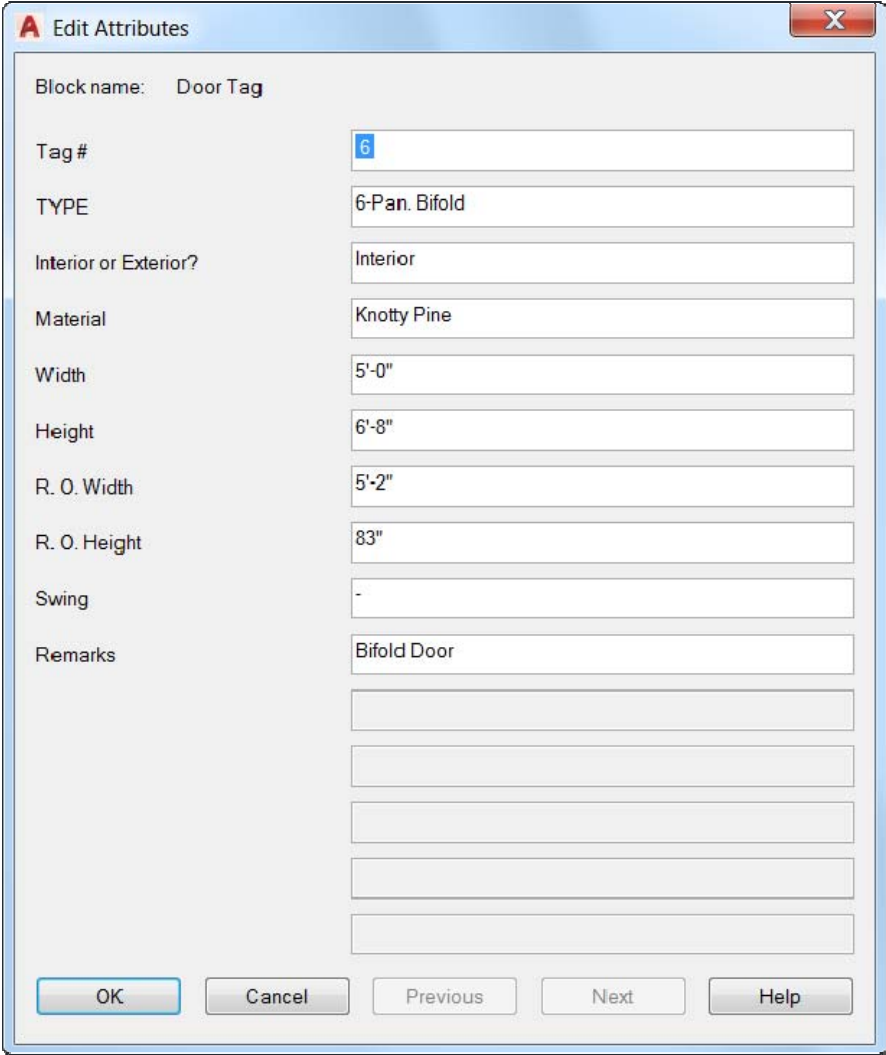

Enhanced Attribute Editor – Access the Enhanced Attribute Editor from the Block panel of the Insert ribbon tab.

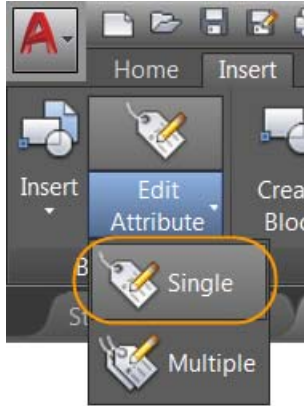

You can increase the size of the Enhanced Attribute Editor to increase the widths of the panels and fields, and the list of attributes visible at one time.

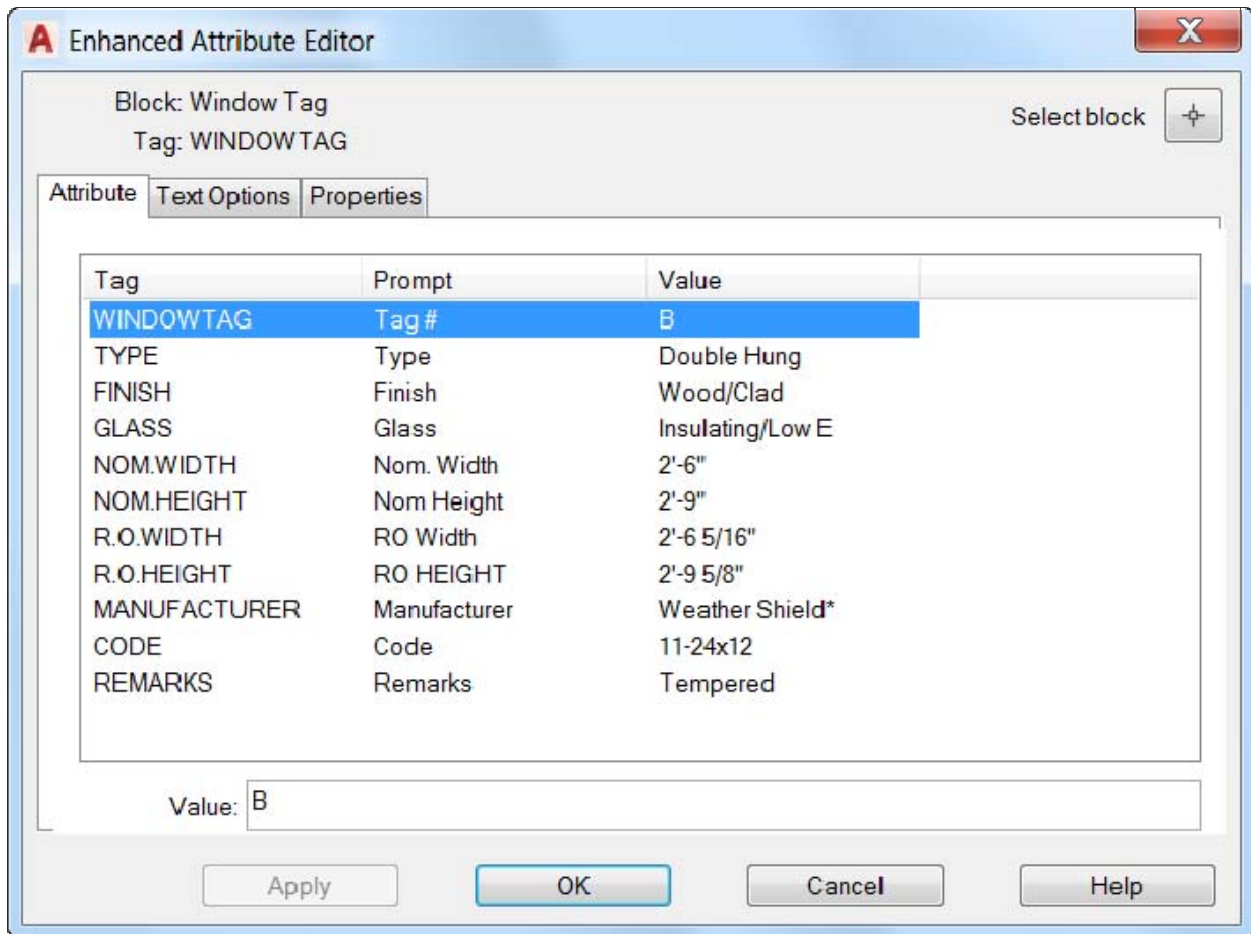

Move or Copy – Access the Move or Copy dialog box by right-clicking a layout tab.

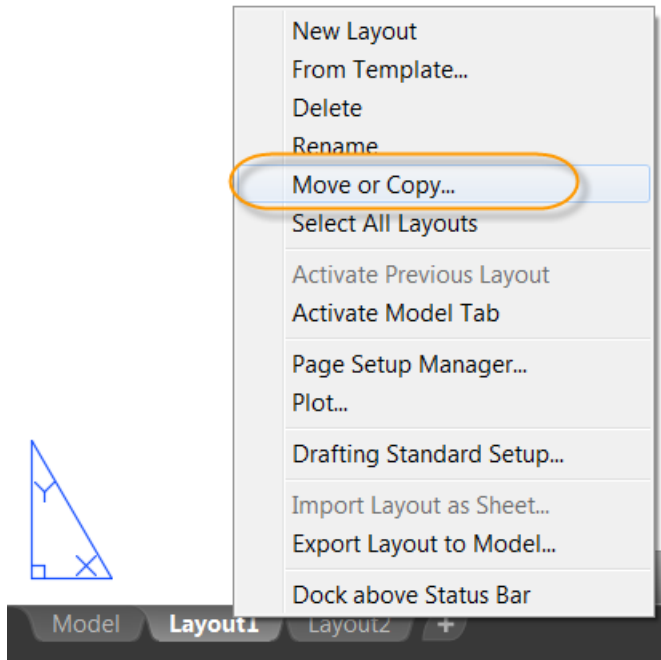

Resize the Move or Copy dialog box to display longer names and more layouts in the layout list.

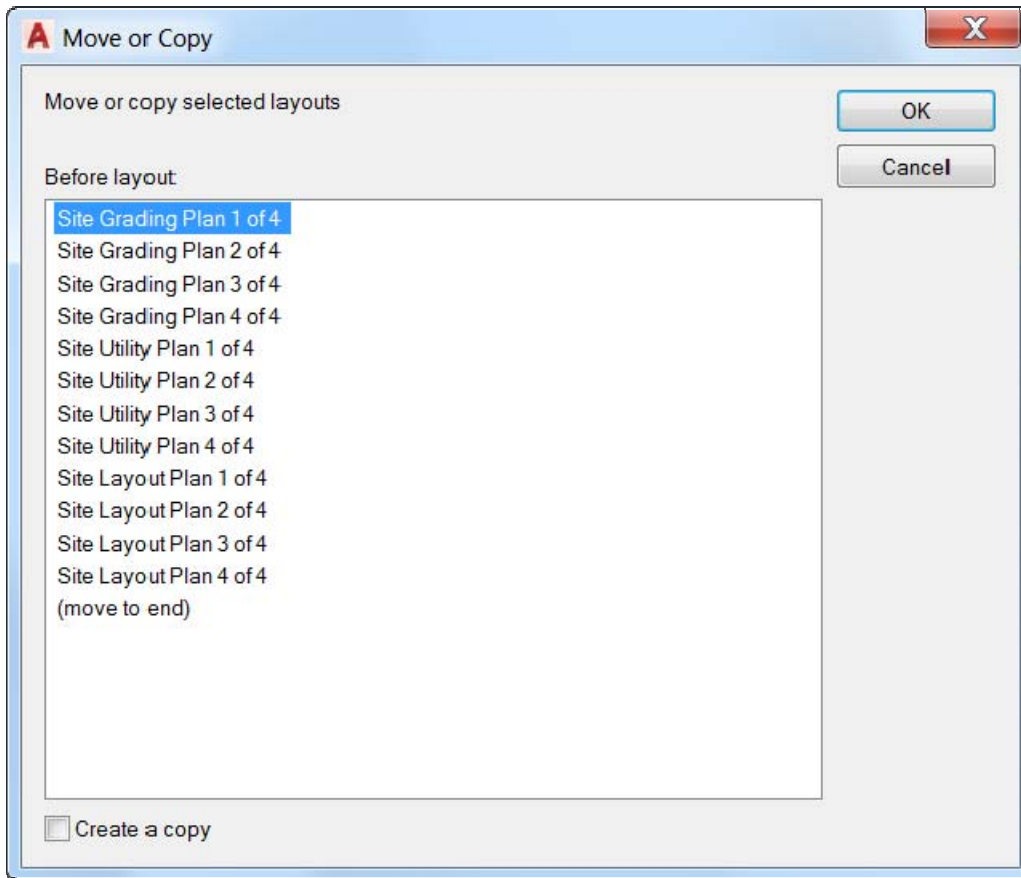

Drawing Properties – Access Drawing Properties from the Drawing Utilities list in the Application menu.

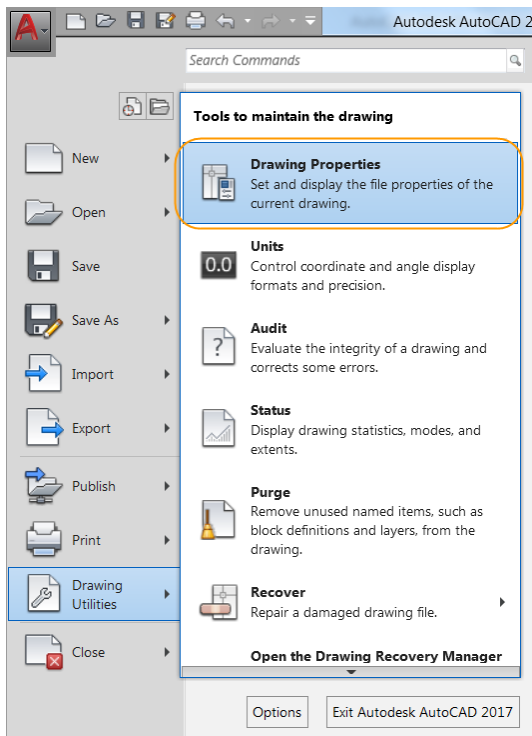

You can resize the Drawing Properties dialog box to display wider fields, more comment text, and more properties at a time. Column sizing is now remembered on the Custom tab.

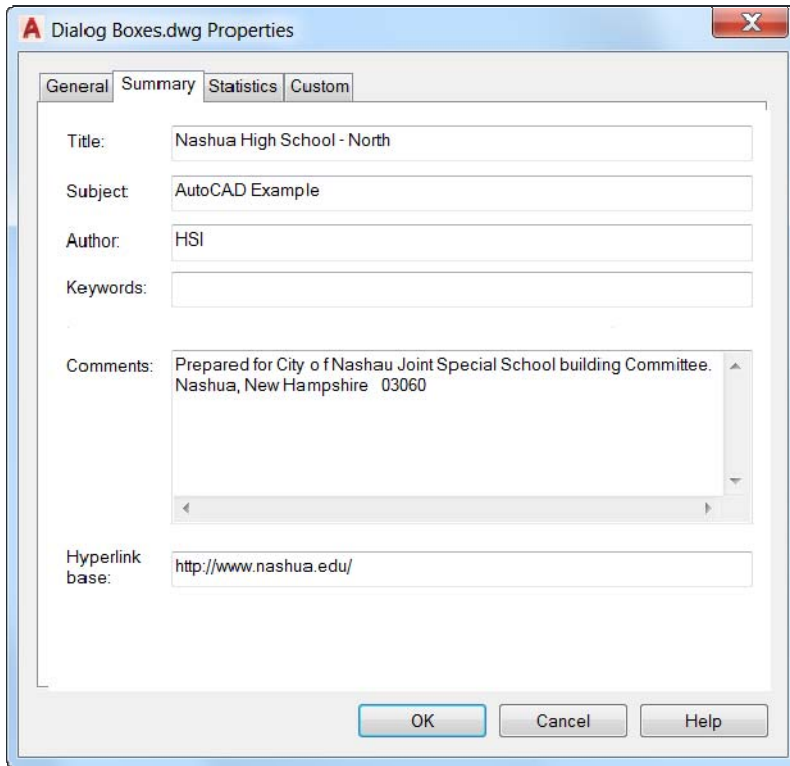

Security Options – Access Security Options from the System tab of the Options dialog box. The display of Trusted Paths is updated. AutoCAD now trusts any files and folders under Program Files, which is under the operating system’s UAC protection. This is indicated by displaying these implicitly trusted paths in the Trusted Paths UI and graying them out. Previously, the implicit Trusted Paths were not displayed.

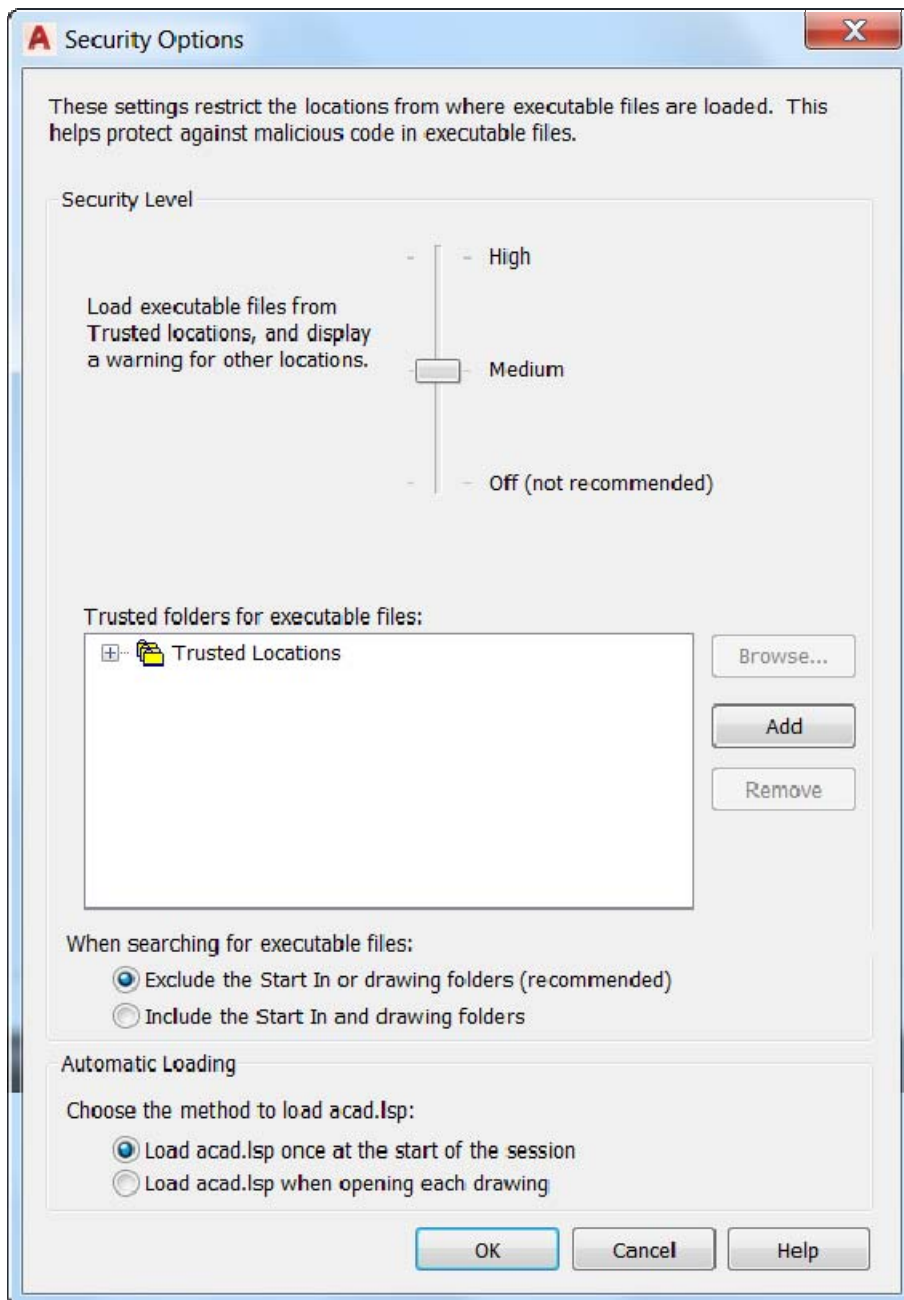

Load/Unload Applications – Access the Load/Unload Applications dialog box from the Applications panel of the Manage ribbon tab.



You can resize the Load/Unload Applications dialog box to enable you to see more information and files without scrolling. Resizing occurs equally between the folder browser window and the Loaded Applications/History list windows.

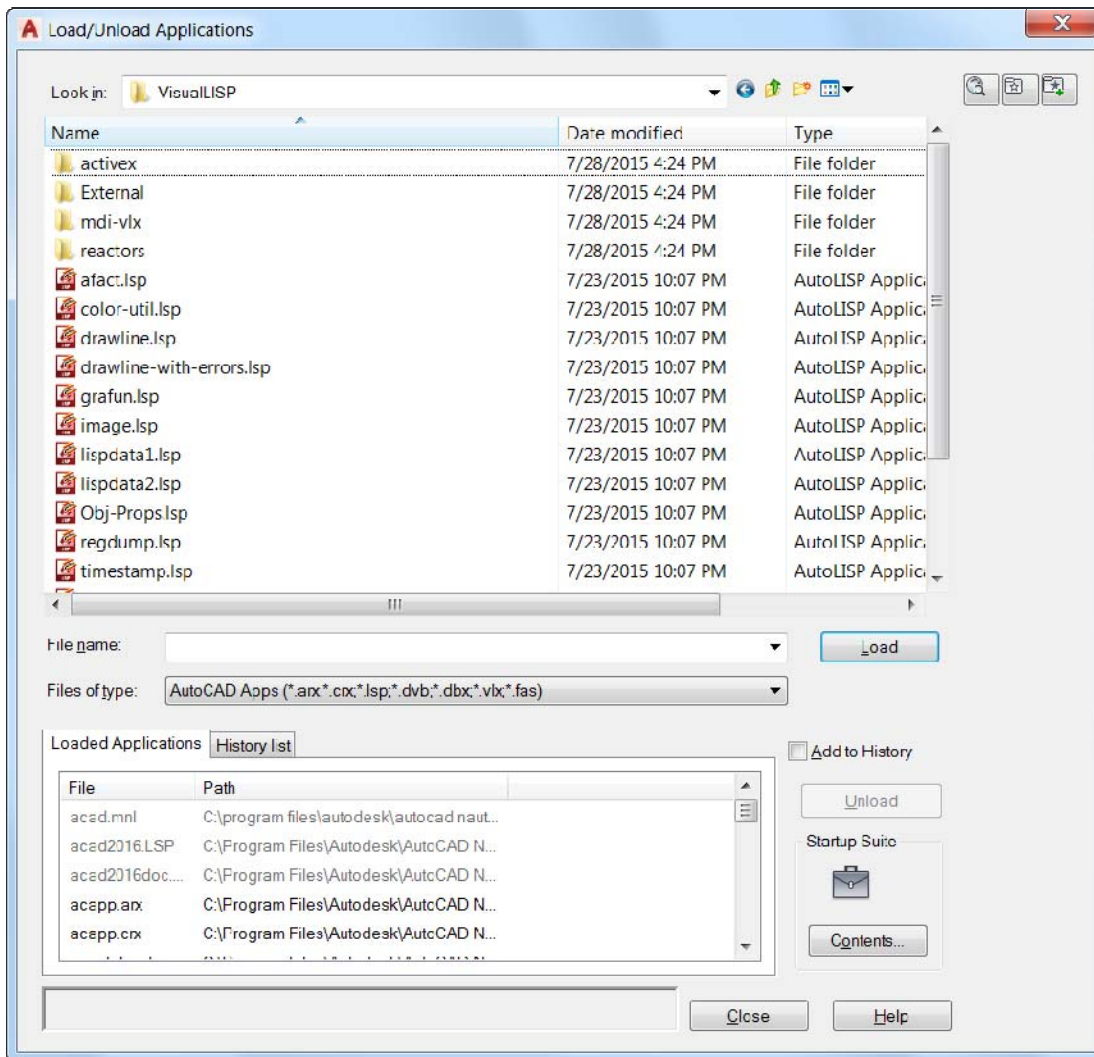

Open VBA Project – Access the Open VBA Project dialog box from the Load Project tool on the Manage ribbon tab. If you have not already done so, you must first install Microsoft® Visual Basic® for Applications (VBA) software. It is not installed by default. For more information, visit <http://www.autodesk.com/vba-download>.

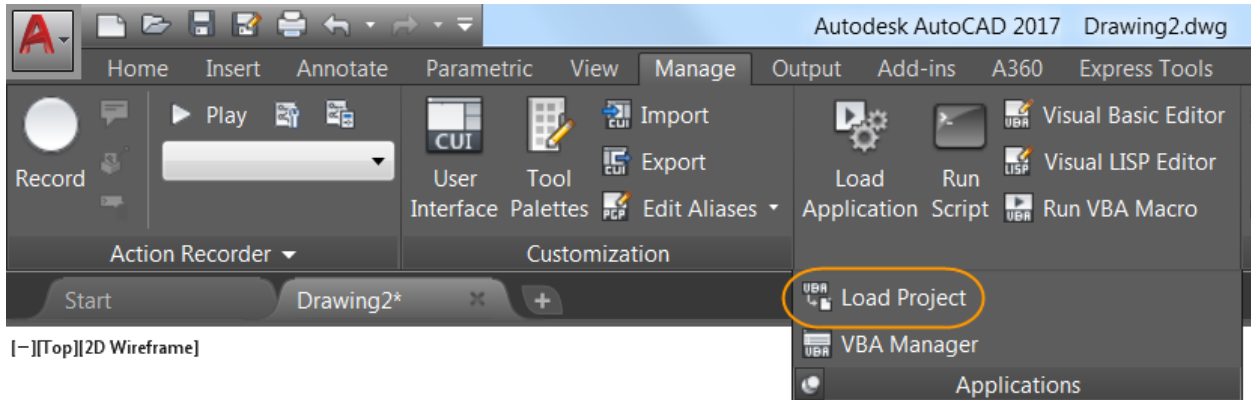

You can resize the Open VBA Project dialog box to display additional information.

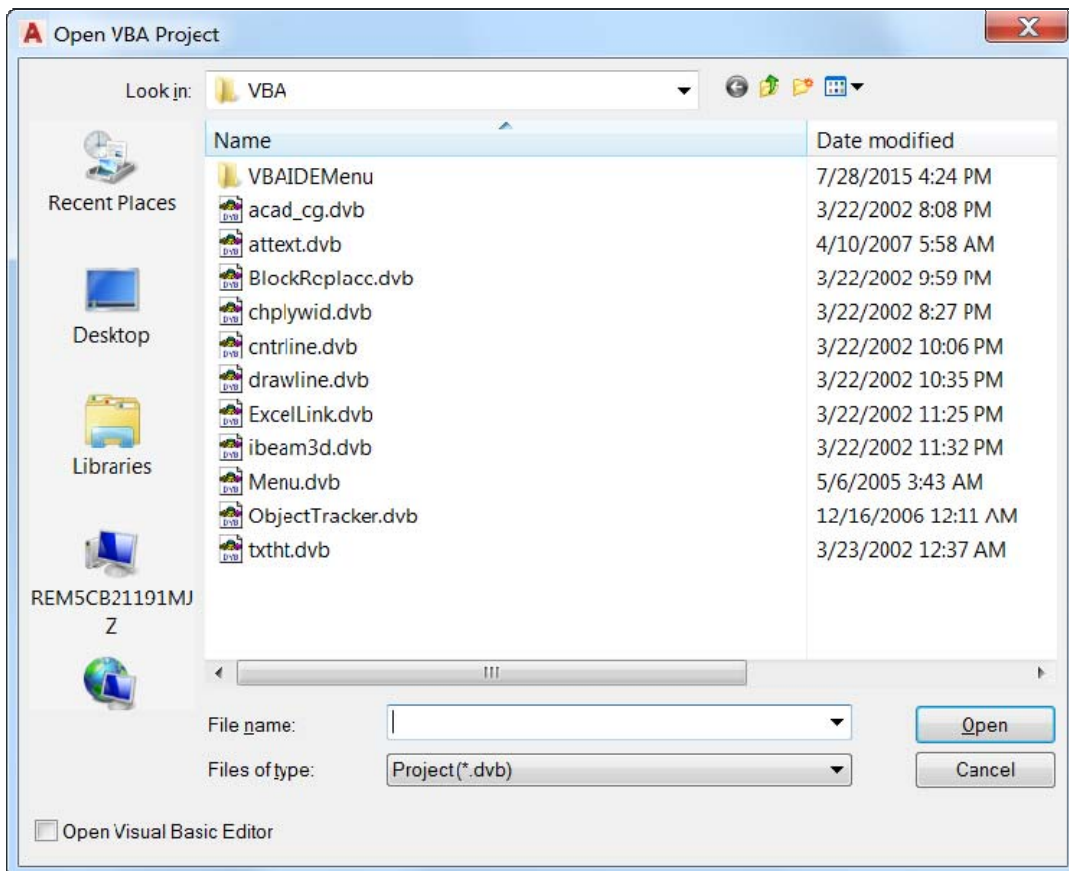

Drawing Units – The Drawing Units dialog box is updated to include US Survey Feet in the list of insertion units.

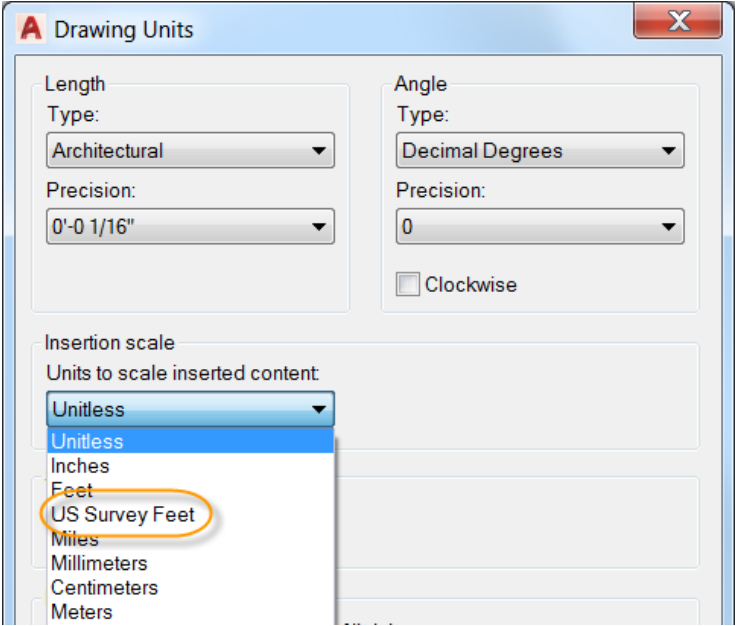

ToolTip enhancements

A new control on the Display tab of the Options dialog box enables you to specify the number of seconds to delay the display of rollover tooltips when passing the cursor over a UI element. You can take advantage of tooltips when you really need them without the distraction of displaying them when you don't.

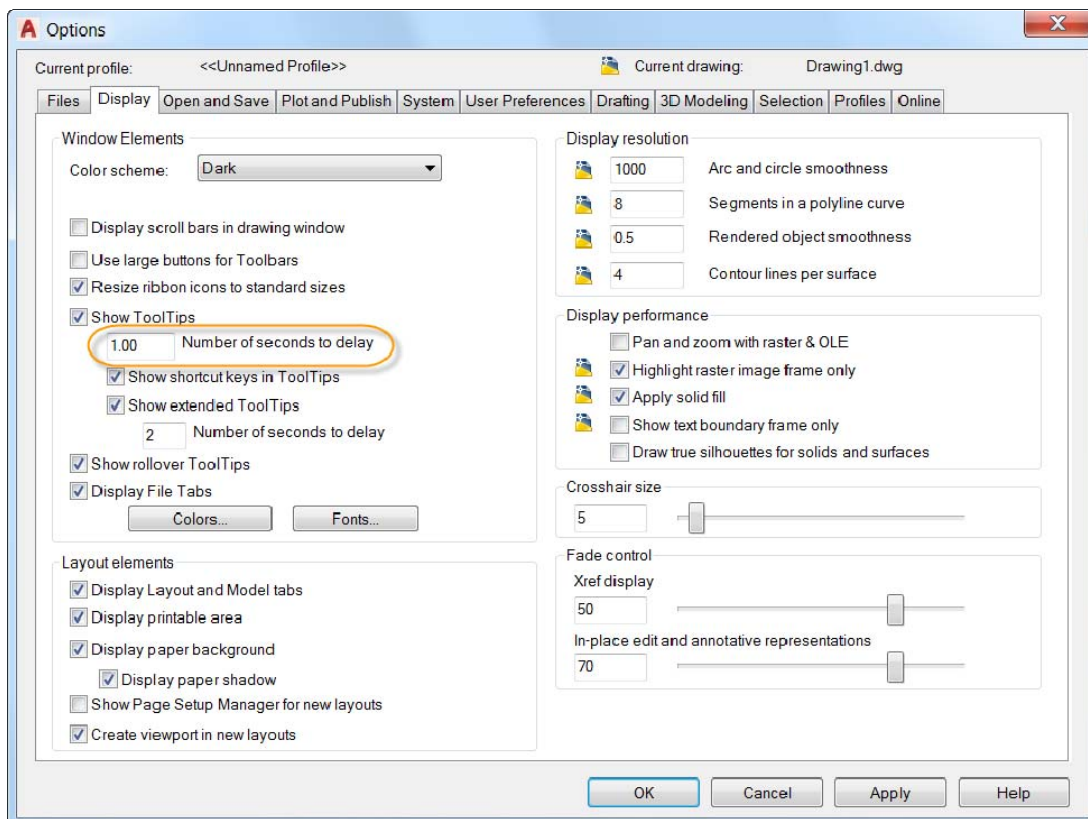

Delete key

A message displays if you try to delete selected objects using the Delete key when the PICKFIRST system variable is set to zero.

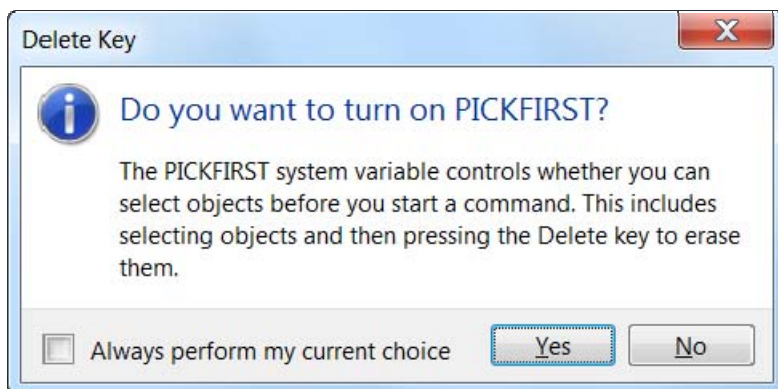

You can avoid displaying the message in the future by selecting the option to always perform your current choice. Doing so adds the Delete key message to the Hidden Message Settings, which you can access from the System tab of the Options dialog box.

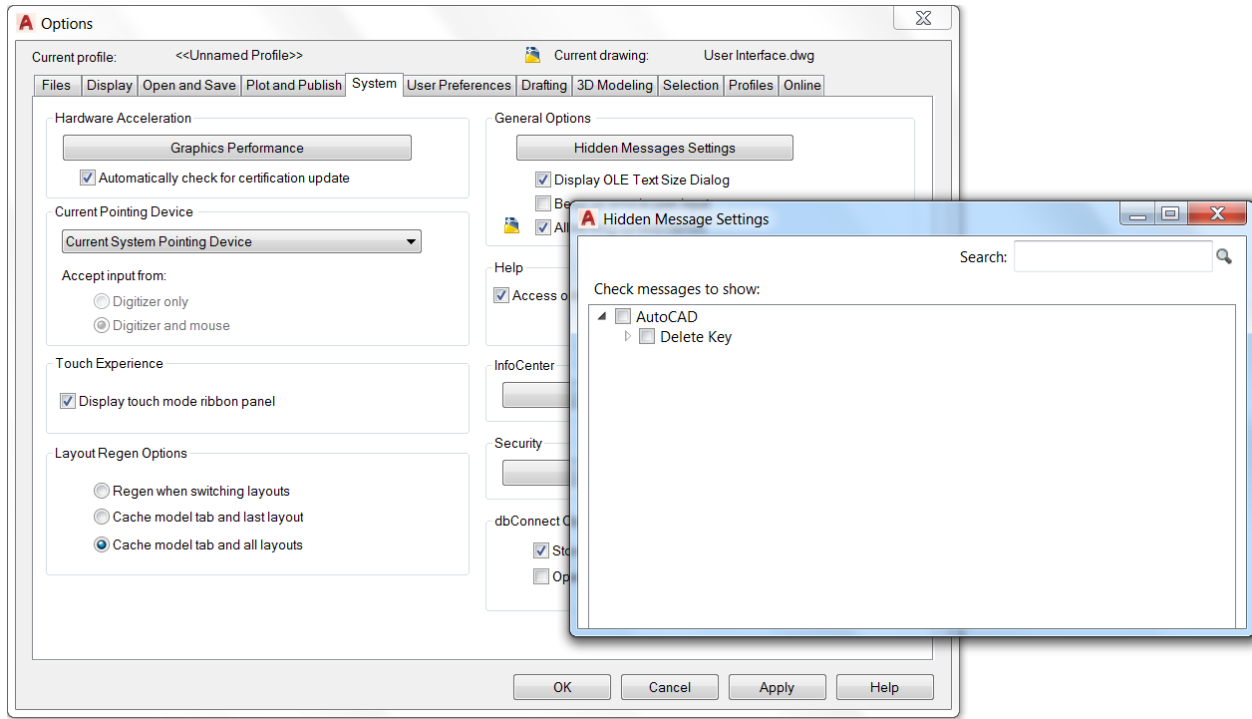

Hatch layer

The HPLAYER system variable has been expanded to enable you to specify a non-existing layer and set it as default for new hatches and fills.

TEXTEDIT command

The TEXTEDIT command includes a new Mode option (TEXTEDITMODE system variable) to enable you to edit multiple text objects without having to restart the command.

```

TEXTEDIT
Current settings: Edit mode = Single
Select an annotation object or [Mode]: m

```

```

TEXTEDIT Enter a text edit mode option [Single Multiple] <Single>:

```

When the Multiple option is selected, TEXTEDIT repeats, which enables you to continue selecting text objects for editing. An Undo option within Multiple mode enables you to undo previous editing operations.

```

Select an annotation object or [Mode]: m
Enter a text edit mode option [Single/Multiple] <Single>: M
Current settings: Edit mode = Multiple

```

```

TEXTEDIT Select an annotation object or [Undo Mode]:

```

Associative centerlines and center marks

AutoCAD 2017 offers powerful new tools for creating and editing centerlines and center marks. You can access the Center Mark and Centerline tools from the Annotate ribbon tab.

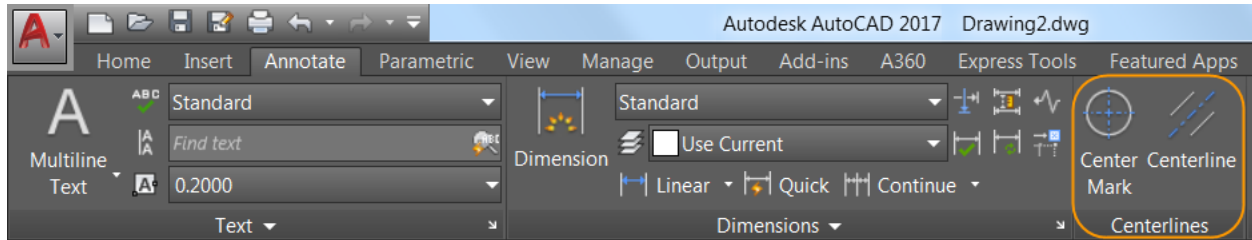

The Centerline tool creates centerline geometry of a specified linetype in association with selected lines and polylines. The Center Mark tool creates an associative center mark at the center of a selected circle, arc, or polygonal arc. If you move the associated objects, the centerlines and center marks update accordingly.

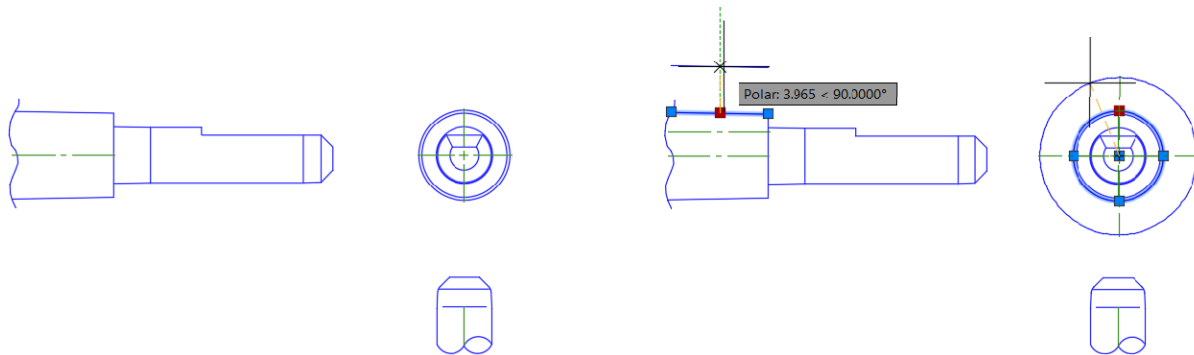

You can disassociate centerlines and center marks from objects using the CENTERDISASSOCIATE command. Use the CENTERREASSOCIATE command to reassociate centerlines and center marks with selected objects.

The appearance of centerlines and center marks is controlled by the following system variables:

CENTEREXE – Controls the length of extension line overshoots centerlines and center marks.

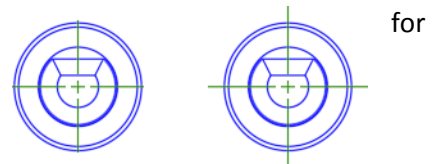

CENTERMARKEXE – Determines whether extension lines are created for center marks.

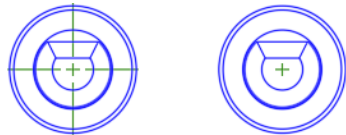

CENTERLTYPE – Specifies the linetype used by centerlines and center marks.

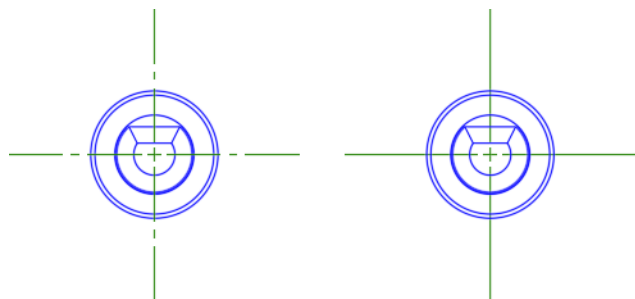

CENTERLAYER – Specifies the layer on which centerlines and center marks are created.

CENTERLTSCALE – Sets the linetype scale used by centerlines and center marks.

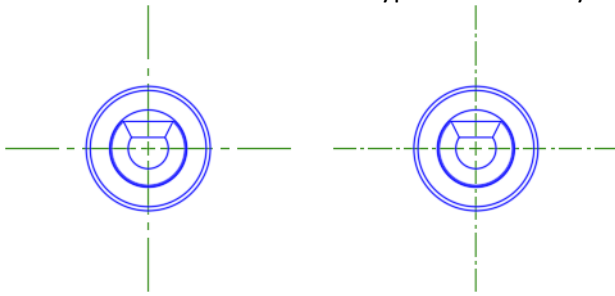

CENTERCROSSSIZE – Determines the size of the central cross for center marks.

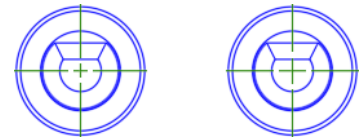

CENTERCROSSGAP – Determines the extension line gap between the central cross and the extension lines of center marks.

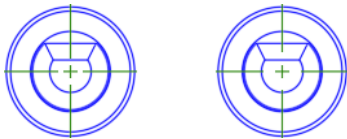

You can modify centerlines and center marks with their grips. A multifunctional grip menu offers additional controls.

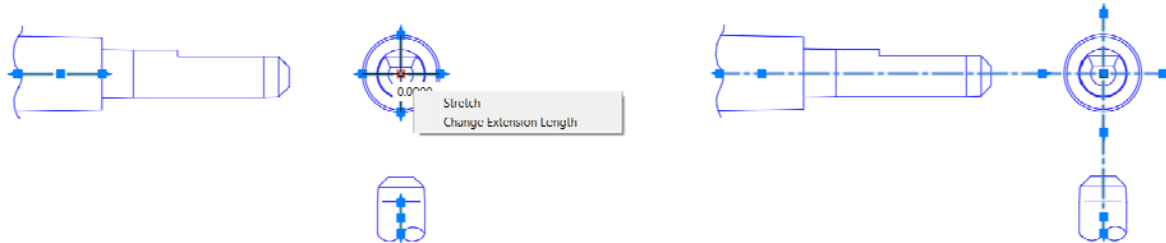

You can use the Properties palette to view and edit centerline and center mark properties.

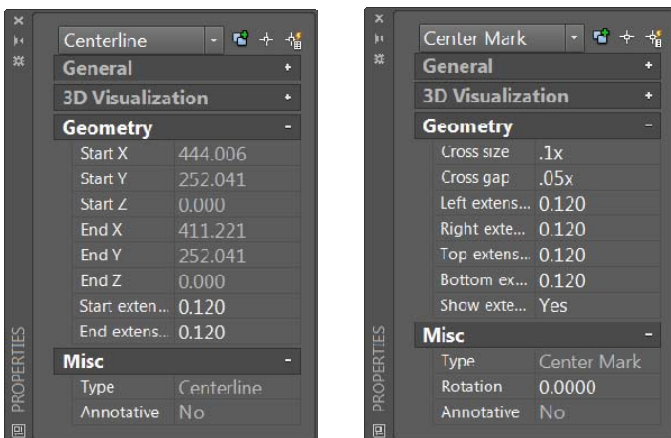

Use the CENTERRESET command to reset the extension lines of a center mark or centerline object to the current value of CENTEREXE.

Personalized

Smooth migration

The new Migrate Custom Settings tool offers a modern and informative interface for migrating your custom settings and files from a previous release to AutoCAD 2017. It detects and clearly identifies customized settings, enabling you to choose which ones you wish to migrate.

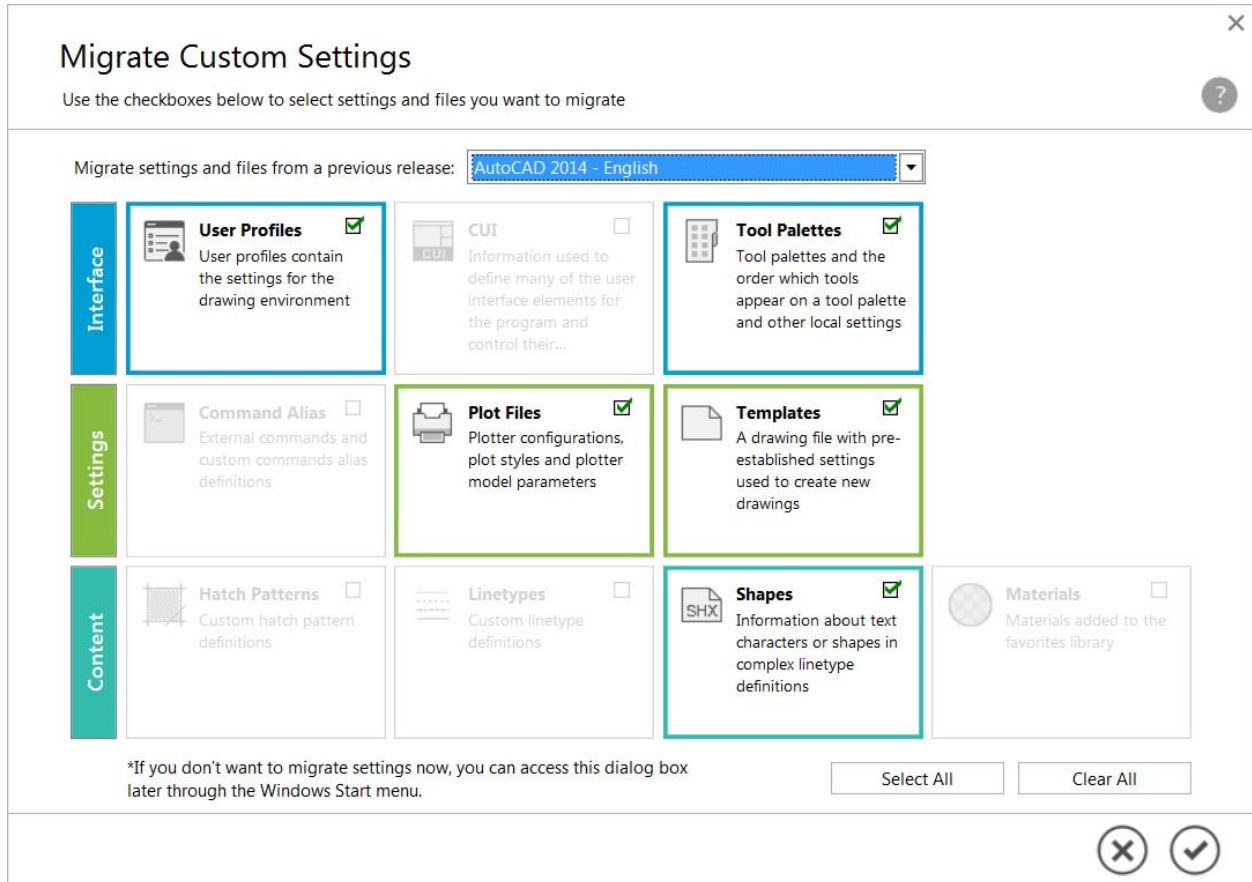

The summary report created from the migration is redesigned to offer more information in an easier-to-read format.

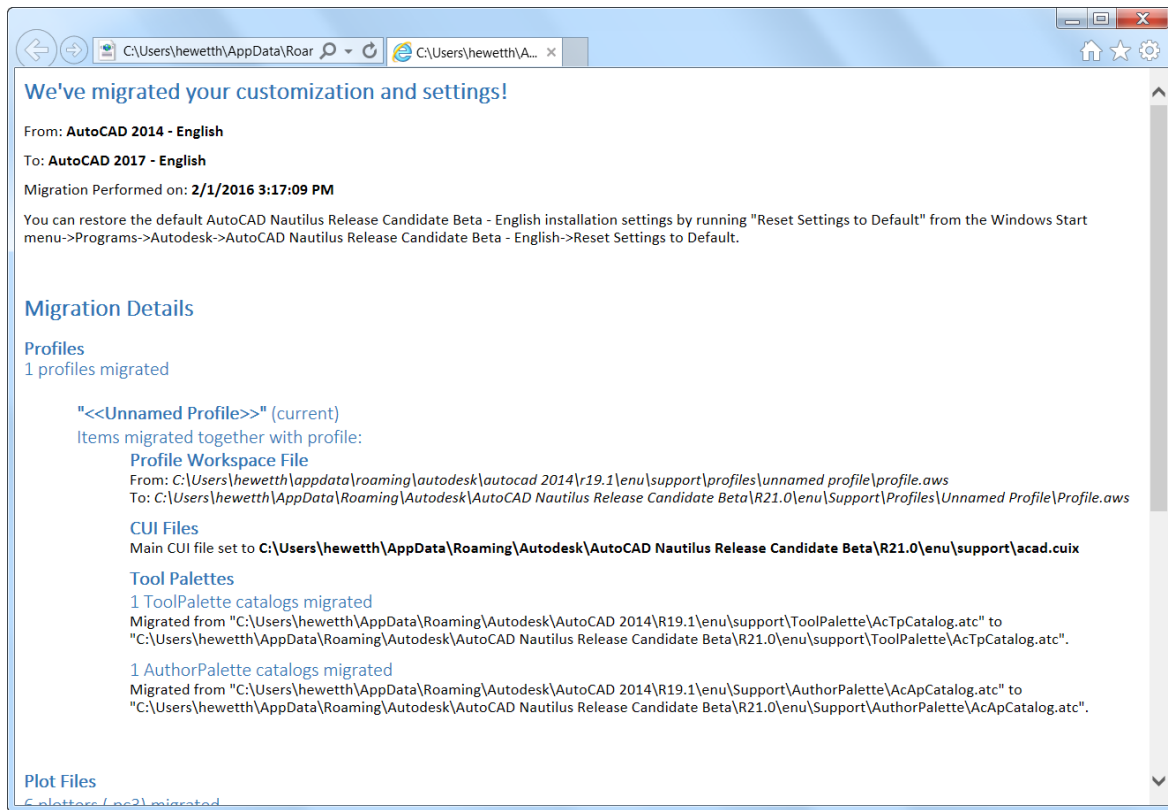

Autodesk desktop app

One of the first changes you may notice when installing AutoCAD 2017 is the new Autodesk desktop app window, which is automatically displayed after the install is complete.

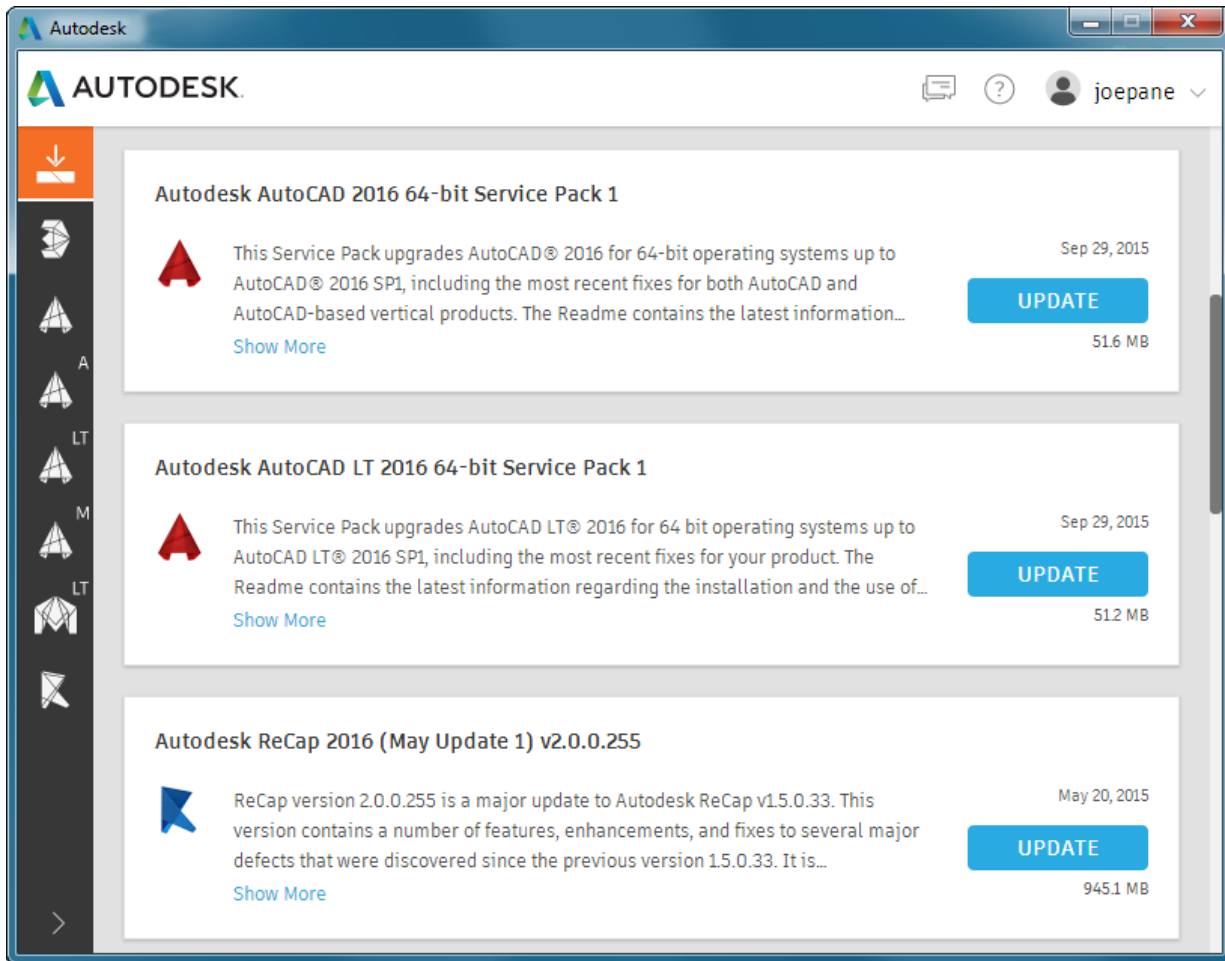

An Autodesk desktop app shortcut is also installed on the window's desktop and taskbar for easy access later.



Autodesk desktop app does not require sign-in. However, it provides the most value when you're signed in. If you do not yet have an Autodesk account, you can create one.

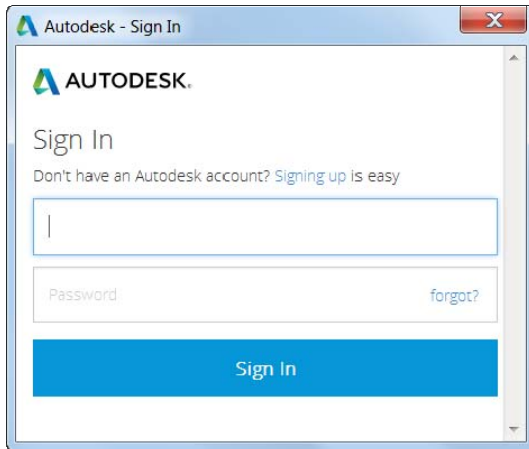

Autodesk desktop app is a companion application that delivers security patches and updates for all 2015, 2016, and 2017 versions of Microsoft® Windows®-based Autodesk® products. It also delivers relevant learning content. Autodesk desktop app replaces Autodesk Application Manager (AAM) and like AAM, Autodesk desktop app supplements (and in some products replaces) in-product notifications of updates. It is subscription-aware, and delivers subscription-only updates and learning content for products under subscription.

When a hot fix, service pack, or security patch becomes available, Autodesk desktop app displays a notification on the system tray. When you launch Autodesk desktop app and open the Updates tab, an update “card” displays the relevant details about the update, including any available learning content about the update. The Updates tab collects all available updates for the Autodesk products installed on the computer. Clicking an Update button downloads and installs that update on your computer.

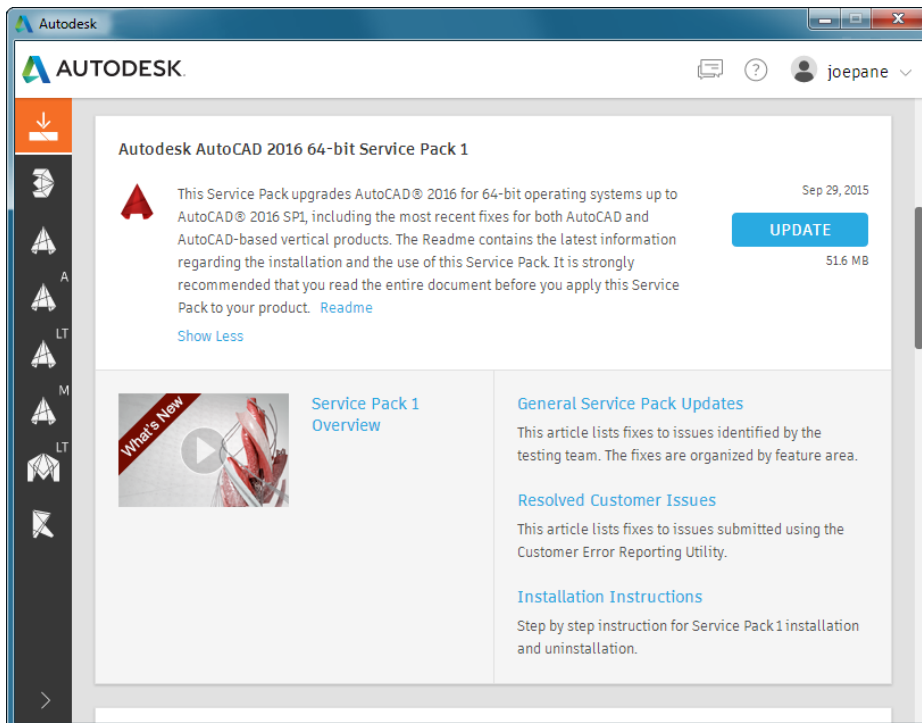

Connected

Importing PDF files

PDF files are a common way of publishing and sharing design data for review and markup. AutoCAD currently supports creating PDF files as a publishing output for AutoCAD drawings. PDF files can be attached to drawings, which can be used as a reference when collaborating on projects. In AutoCAD 2017, you can import the geometry, TrueType text, and raster images from a specified page in a PDF file, or from all or part of an attached PDF underlay.

IMPORT command

The Import tool, available from the Application menu and the Insert ribbon tab, enables you to import geometry from a PDF page into the current drawing as AutoCAD objects.

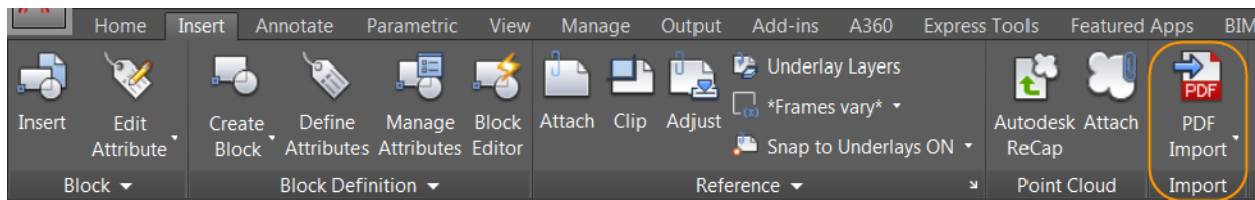
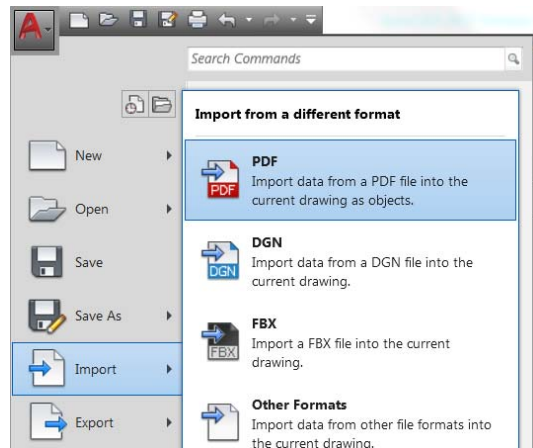

In the Import File dialog box, you'll see that PDF has been added to the list of supported file formats.

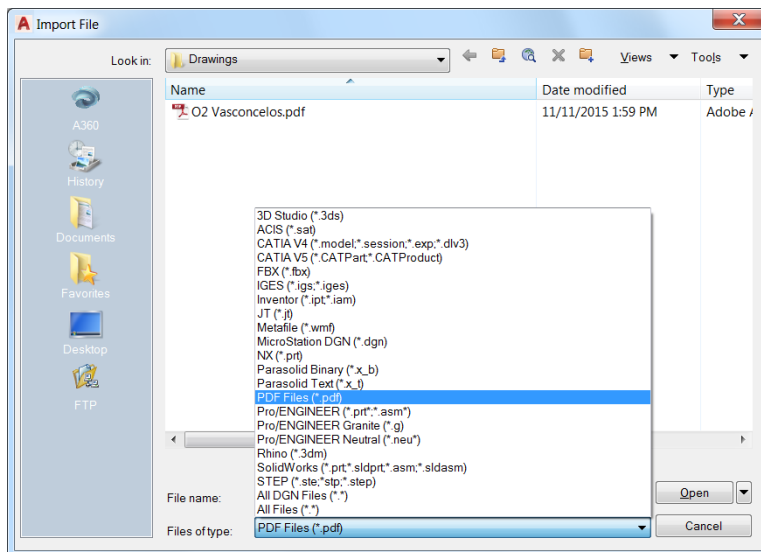

After a PDF file type is selected, the Import PDF dialog is displayed and enables you to:

- Choose which page from the selected PDF file to import
- Specify the scale, rotation, and insertion point of the imported geometry
- Control what type of data is imported from the PDF (Geometry, Solid fills, Text, and Raster objects)
- Control how layers are assigned to imported objects
- Set different post-processing options for imported geometry

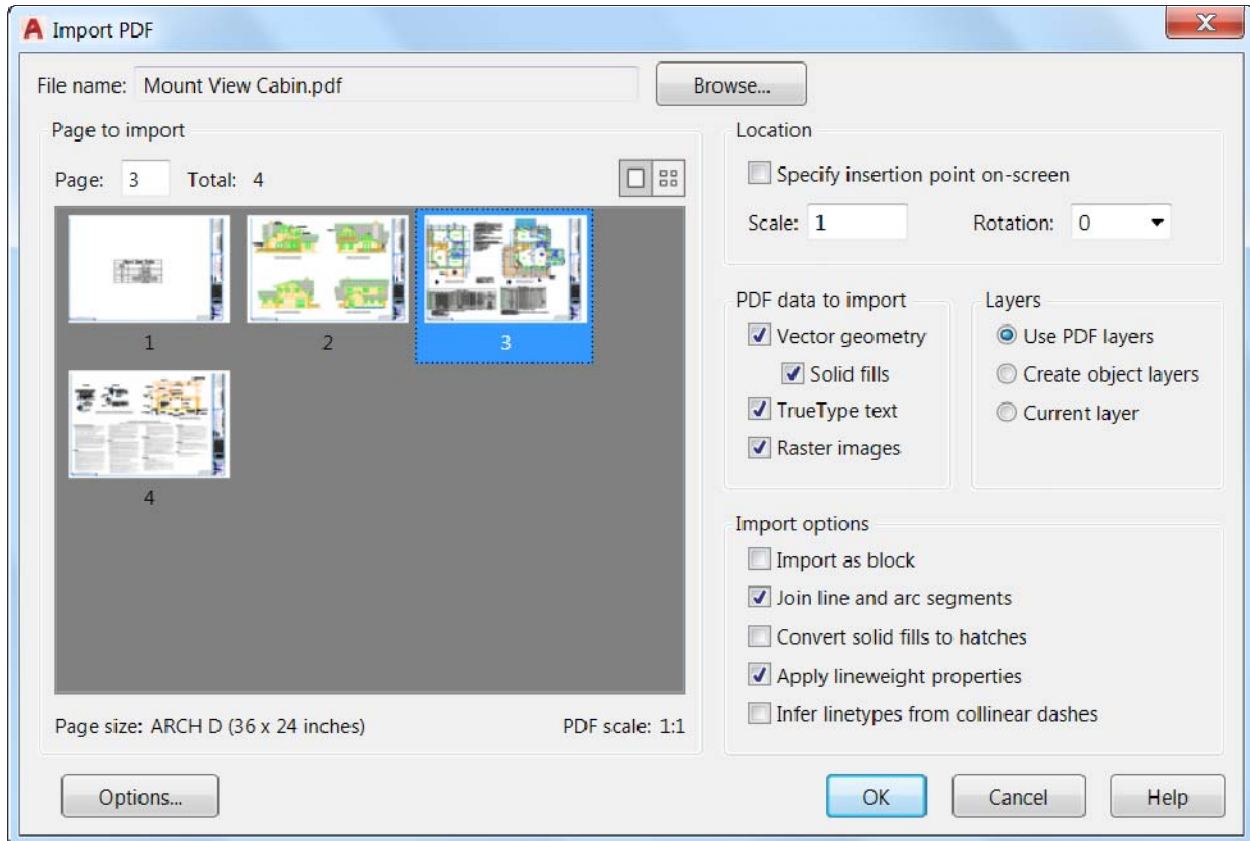

Raster images are extracted as .png files and attached to the drawing.

The “Convert solid fills to hatches” check box joins 2D solids with coincident edges and converts them to hatch objects. This option increases the processing time.

The “Apply lineweight properties” check box applies the lineweights in the PDF to the extracted geometry. When unchecked, all imported geometry is assigned AutoCAD’s default lineweight.

The “Infer linetypes from collinear dashes” check box looks at collections of collinear dash and dot segments and replaces them with a single polyline. A dashed PDF_IMPORT linetype is created and applied to the polyline and assigned a linetype scale based on the length of the dashes. This setting reduces the number of objects and makes it easier to edit the geometry, but some fidelity is lost. If unchecked, each segment in a dashed line is imported as a separate pline.

The Options button at the bottom of the Import PDF dialog box opens the Files tab in the Options dialog box. Here you can specify the file location for image files that are extracted from the PDF and attached to the drawing. Paths can be absolute or relative to the location of PDF file being imported.

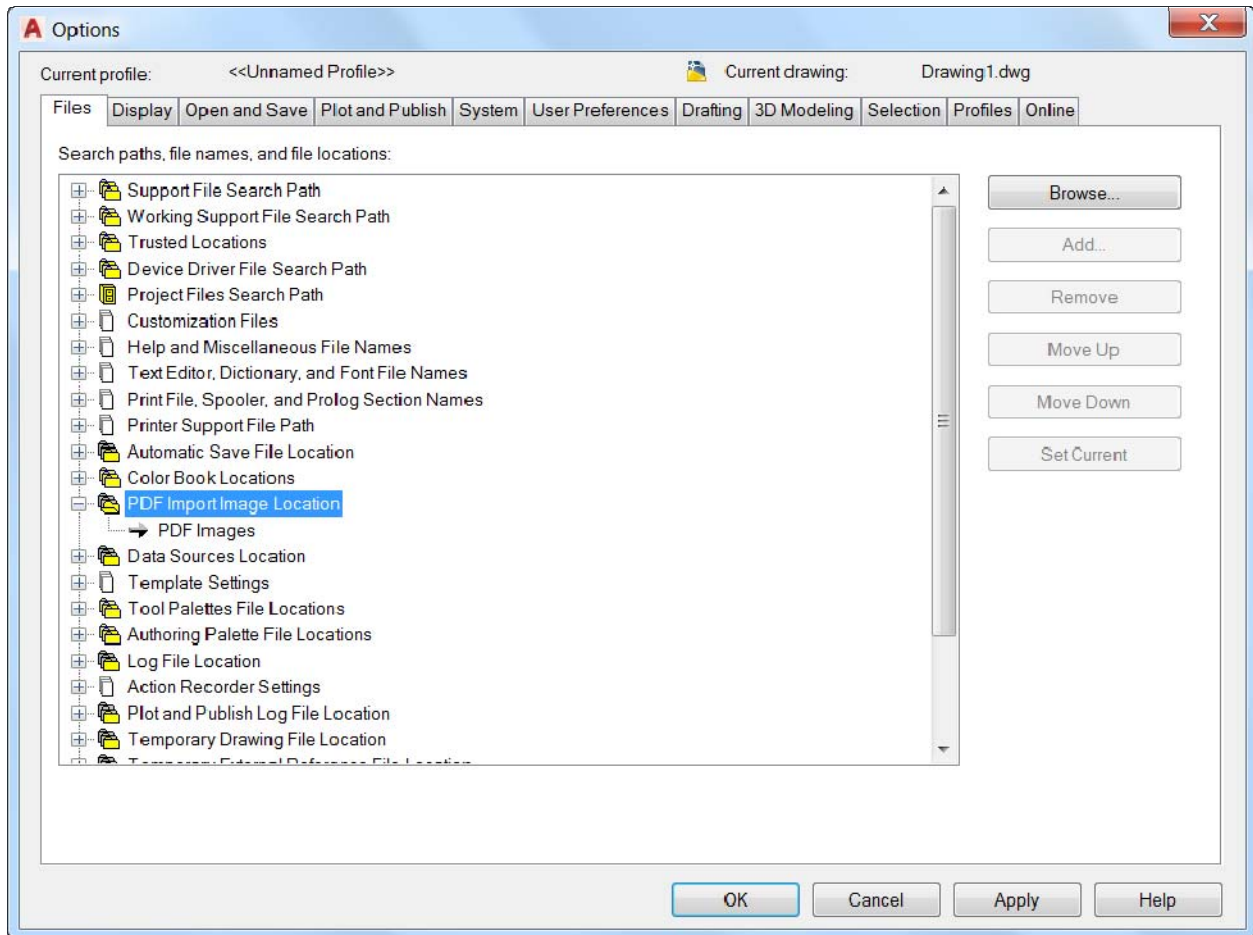

The PDF file format doesn't recognize SHX text. When drawings with SHX fonts are plotted to PDF, the PDF stores that data as geometry (not text), so the SHX text is imported as geometry. Text with TrueType fonts are imported as text objects.

PDFIMPORT/-PDFIMPORT command

The new PDFIMPORT command (–PDFIMPORT for command line access) offers an alternate way for you to import PDF geometry into the current drawing. The initial options provide a choice either to select an attached PDF underlay, or to specify a PDF file.

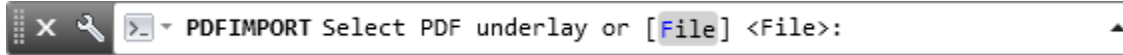

If you choose the File option, the Import PDF dialog box is displayed, just as when you use the IMPORT command.

If you select an attached PDF underlay, you can specify a rectangular or polygonal boundary around the objects you want to import, or you can import everything. You can also choose to keep, detach, or unload the PDF underlay after the objects are imported.

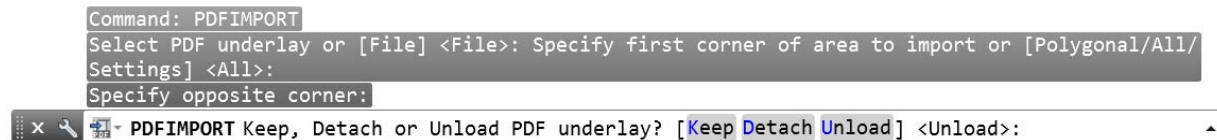

The Settings option in the PDFIMPORT command displays a dialog box that provides the same settings as those in the Import PDF dialog box.

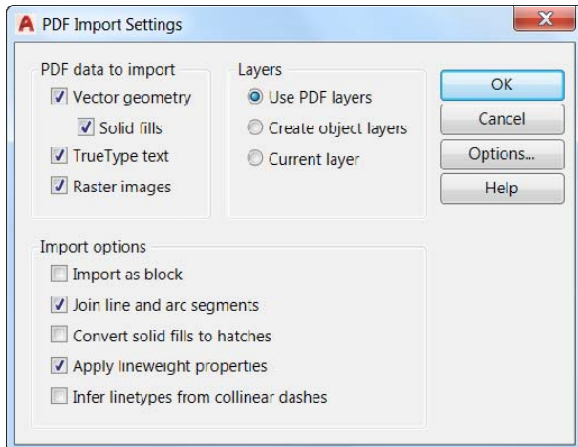

If you select a PDF underlay that is attached to the current drawing, you can access the PDF Import tool from the contextual PDF Underlay ribbon tab.

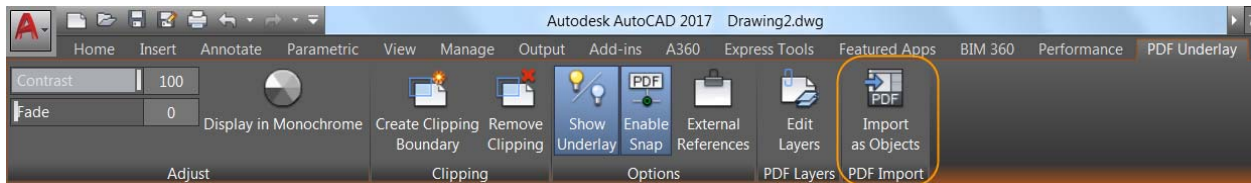

A360

The A360 ribbon tab is updated to support new functionality and remove obsolete and less frequently used tools. The AutoCAD Online ribbon panel and the two tools that were in it have been removed from the A360 ribbon. The AutoCAD® 360 web tool is no longer needed because you can edit online drawings via AutoCAD 360 by opening A360 Drive. The Design Feed is no longer displayed by default and the tool is removed from the A360 ribbon. However, you can still access it with the DESIGNFEEDOPEN command.

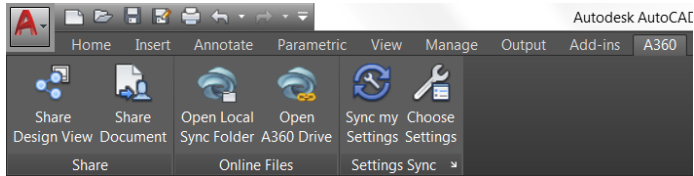

Share Design View

AutoCAD 2017 offers a new tool that enables you to easily publish views of drawings to the cloud to facilitate collaboration with stakeholders while protecting your DWG™ files. Stakeholders viewing the design don't need to log into A360 or have an AutoCAD-based product installed. And they don't have access to the source DWG files, so you can feel comfortable sharing views of your design.

You can access the new Share Design View tool from the Publish flyout on the Application menu or from the A360 ribbon tab with the ONLINEDESIGNSHARE command.

You must be logged into A360 to publish design views. If you are not logged in, you are prompted to do so before the publishing begins.

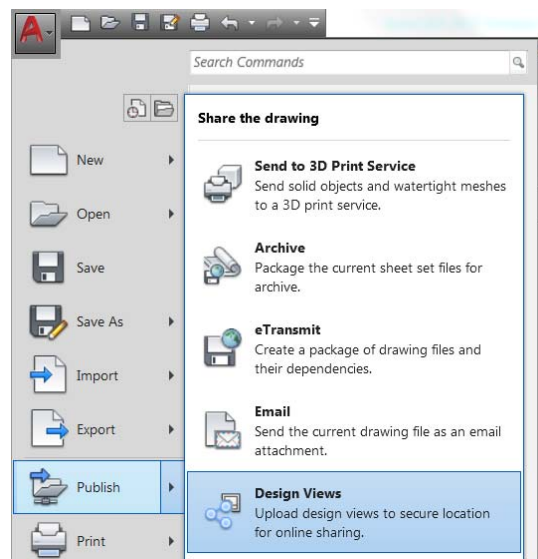
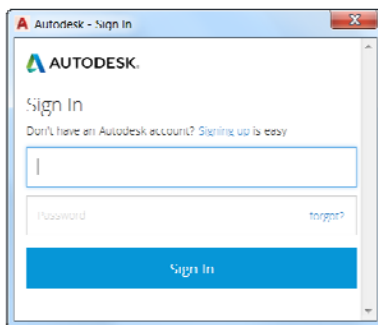

When using the Share Design View tool, your current drawing is uploaded to a secure location in the cloud where 2D and 3D views are extracted along with the property database. You can choose to publish and display in your browser right away or receive a notification from the status bar when all view processing is complete.

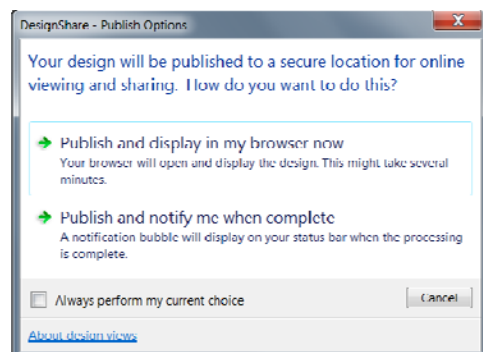

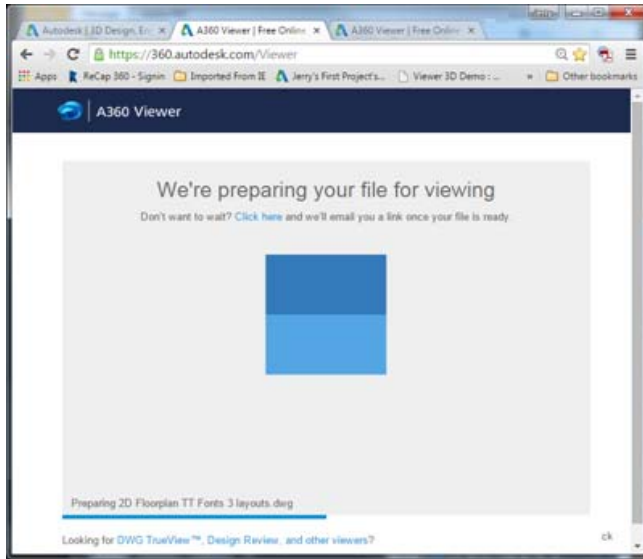

If you choose the option to display in your browser now, AutoCAD uploads the drawing file (and its references) to an OSS storage location on the cloud for processing and launches your browser. You can see the status in the A360 viewer as the file is being prepared for viewing. The processing time will vary depending on the size and complexity of the drawing, internet speed, and backlogged queues for processing.

When processing is complete, the design views are displayed in the viewer in your browser. The viewer is supported by the latest versions of Chrome™, Firefox®, Safari®, or Internet Explorer®. Closing the browser before processing is complete does not cancel the uploading and processing of the design views.

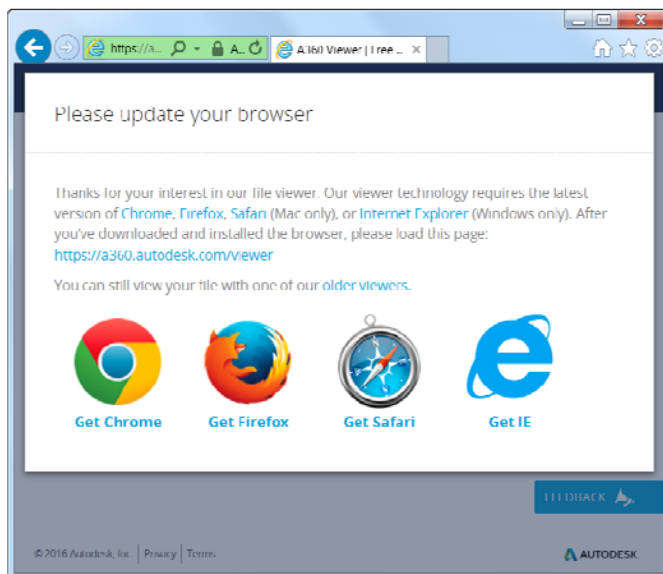

From the viewer, you can navigate the design, measure, display object properties, turn layers on and off, and so on. If you are satisfied with the design view, you can share a link to the design view with other users by emailing, messaging, or posting it somewhere the recipient has access. Users who receive and click on the link will be able to see the design view in their browser for up to 30 days without any logon requirements.

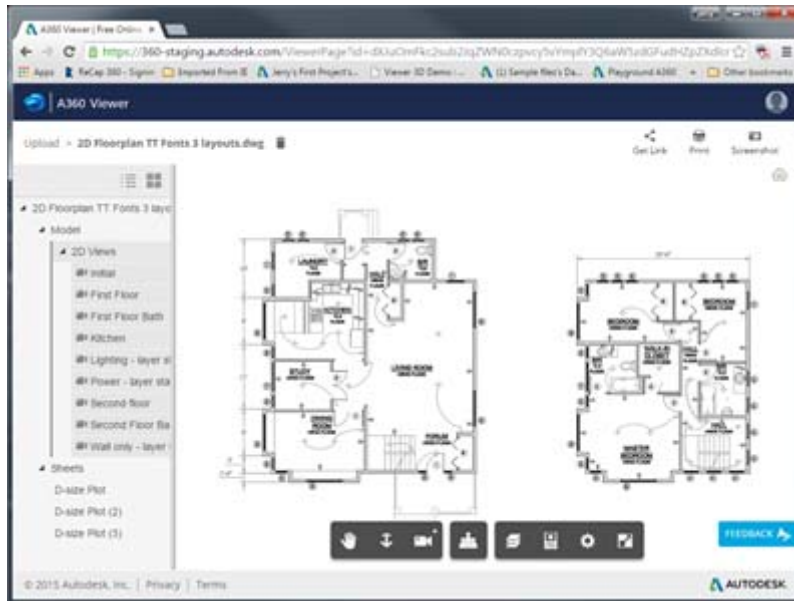

If you choose the option to publish and be notified when processing is complete, design views are created in the cloud but your browser is not launched. Instead, when processing is complete, AutoCAD displays a bubble notification with a link to display the design view in your browser.

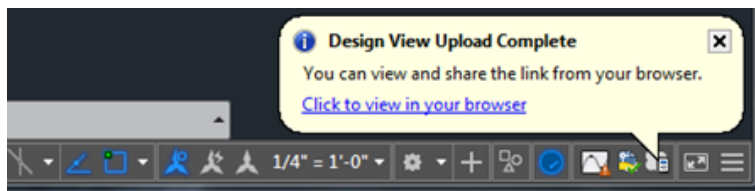

Additional Benefit When You Subscribe: AutoCAD 360 Pro

Take the power of AutoCAD wherever you go! AutoCAD 360 Pro is now included when you subscribe to AutoCAD. AutoCAD 360, the official AutoCAD mobile app, is an easy-to-use drawing and drafting mobile app that allows you to create, view, edit and share AutoCAD drawings on your phone/tablet - anytime, anywhere. AutoCAD 360 Pro comes with advanced features like: · Markup, add text and make changes to drawings in real time · Connect to external cloud storage (Google Drive, Dropbox etc.) · Access advanced layer management, measuring and annotation tools · Ability to work offline and sync changes when back online. Note this benefit is not available to AutoCAD customers on a maintenance plan or a perpetual license.

3D printing

AutoCAD 2017 offers two methods for sending your 3D models to a 3D printer. You can choose the option to Send to 3D Print Service, which launches the 3DPRINTSERVICE command (formerly 3DPRINT). Or, you can choose the Print Studio option, which now launches the 3DPRINT command. Both of these tools are available on the Output ribbon tab when the 3D Modeling workspace is active, as well as from the Application menu.

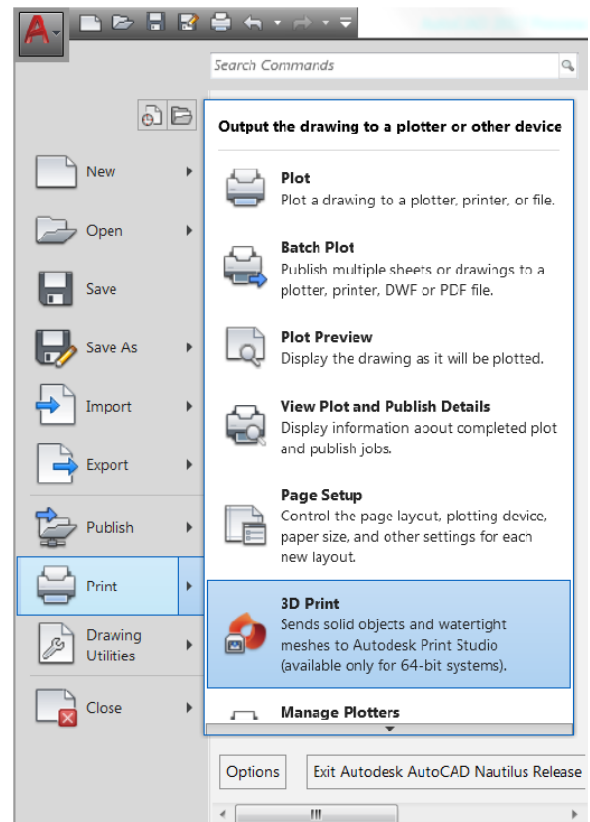
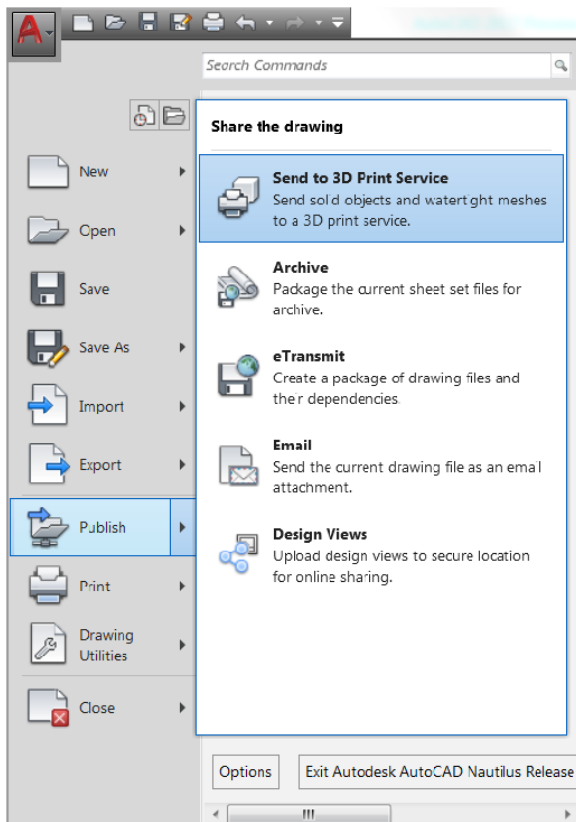
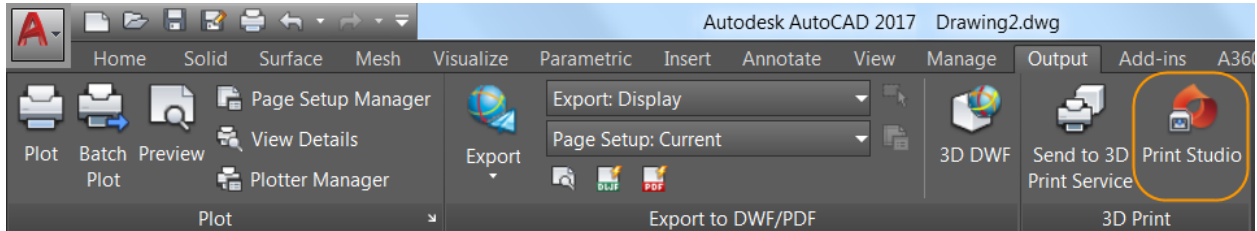

Choosing either tool opens the 3D Print Options dialog box, where you can view and edit various settings, including the output dimensions.

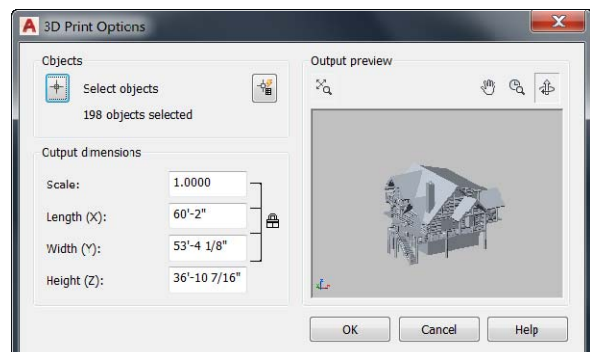

After clicking OK, you are prompted to save the output file to STL format that you can then send to a 3D Print Service, or you are taken to Print Studio—depending on which method you originally chose. Print Studio is a separate application that ships with AutoCAD 2017 but is not installed by default. If Print Studio was not previously installed, you are offered the opportunity to install it.

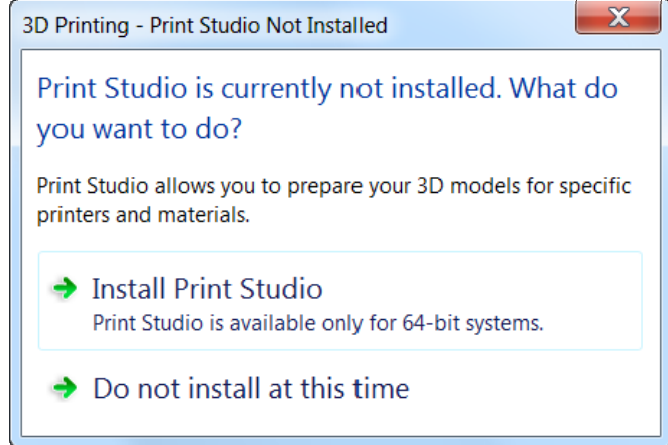

With Print Studio installed, you can connect to the 3D printer to which you want to send your 3D model, or you can create a print file for printing later.

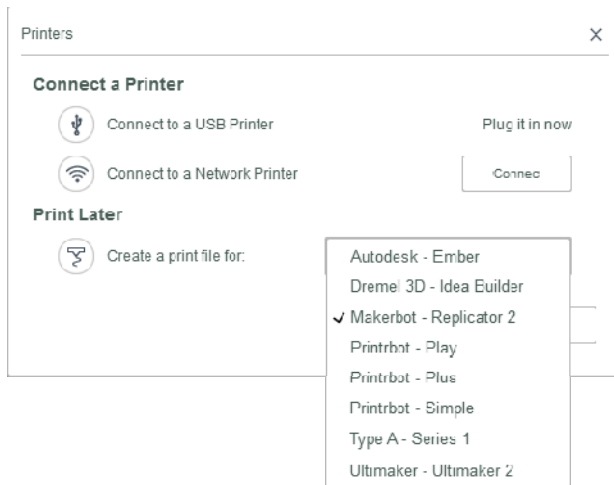

Use Print Studio to help ensure that each of your 3D printing jobs is successful. Print Studio gives you the tools you need to prep your models for specific printers and materials. Importing a completed model into Print Studio and using the available preparation tools can help ensure printing success. This preparation can save time and money by helping you to avoid the frustration of trial-and-error printing.

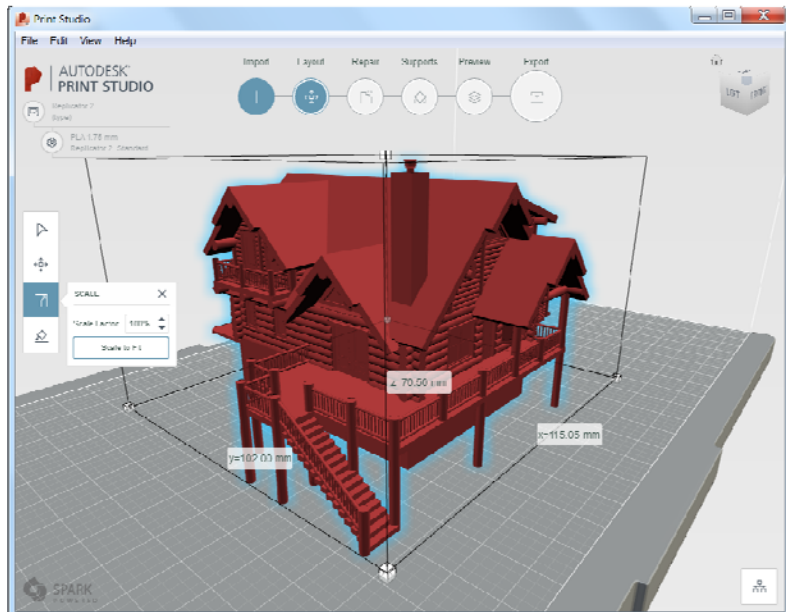

Coordination model object snap

Coordination model functionality has been enhanced in AutoCAD 2017 to enable you to snap to precise locations on an attached coordination model using the standard 2D endpoint and center object snaps. Attach an Autodesk® Navisworks® coordination model from the Attach tool on the Insert ribbon tab and then access endpoint and center object snaps using typical methods.

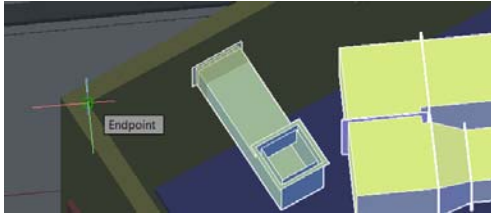

Innovative

Graphics

The appearance, selection, and performance of 2D geometry continues to improve in AutoCAD 2017. You can experience the performance increase if you have a DirectX 11®-capable graphics card and hardware acceleration turned on. A control in the Graphics Performance dialog box enables you to take advantage of improved graphics for capable devices. You can access Graphic Performance from the Status bar icon.

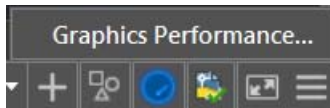
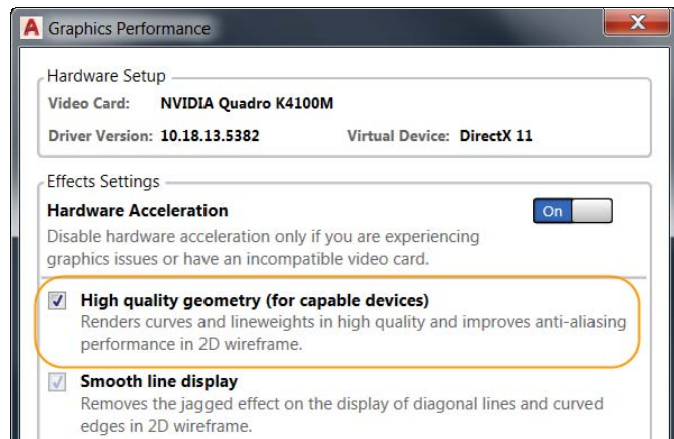

Appearance and selection

In previous releases of AutoCAD, the preview of objects as they're being created, moved, or copied could appear jagged.

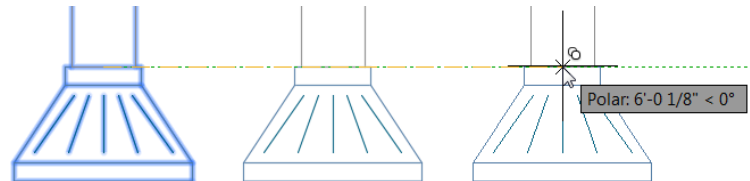

In AutoCAD 2017, line smoothing is supported during the preview, so objects appear just as they will appear after the operation is completed.

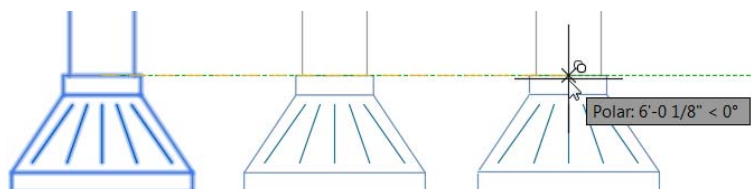

In previous releases of AutoCAD, lines with DOT linetypes could be difficult to see even with lineweights applied. AutoCAD 2017 supports the lineweight display of DOT linetypes, as shown.



In addition, linetypes with dash and dot combinations display round dots, unlike previous releases that represented dots with very short dashes.

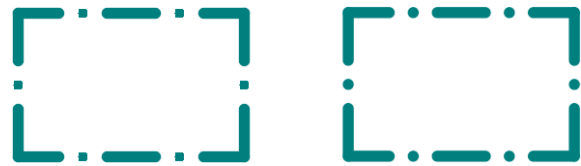

This also results in a more accurate display of selection highlighting.

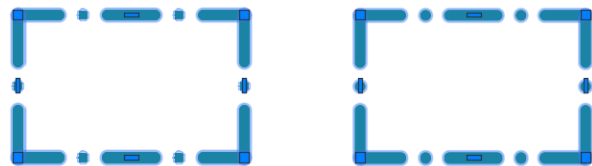

Another subtle but useful improvement to linetypes with dashes and dots is the ability to select or snap to the gaps on those objects. Similarly, the gaps are recognized by object snaps, enabling you to snap to the objects even when picking on a blank space. You can enable this behavior with the new LTGAPSELECTION system variable.

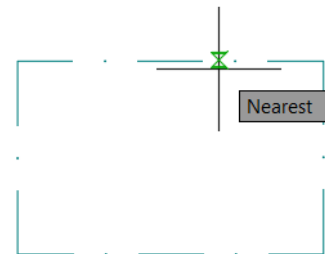

The appearance of closely spaced parallel hatch lines is improved for more consistent line spacing.

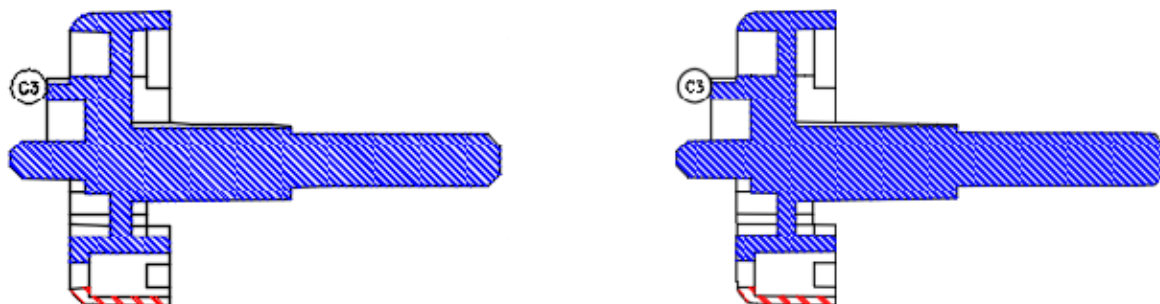

2D performance

Performance for 2D graphics is improved in AutoCAD 2017 by taking advantage of the graphics processing unit (GPU) that is present in many modern display adapters. This has been done in two ways. First, linetypes that include only dashes and dots are now generated by the GPU, rather than relying on the CPU to create the individual parts. Second, graphics are now cached (retained) in GPU memory, which can make pan and zoom operations significantly faster.

3D interaction, stability, and performance

AutoCAD 2017 offers improved stability and performance with a new 3D graphics subsystem. You can view and orbit large 3D models, with visual styles, without experiencing adaptive degradation, which automatically turned off visual features during interactive display operations in order to maintain an acceptable frame rate.

The performance for 3D drawings has been improved, in general, but specifically for models with a large number of small blocks containing edges and facets. Use any of the 3D Navigation tools to experience the improved performance.

Autodesk, the Autodesk logo, AutoCAD, Buzzsaw, DWG, and Navisworks are registered trademarks or trademarks of Autodesk, Inc., and/or its subsidiaries and/or affiliates in the USA and/or other countries. All other brand names, product names, or trademarks belong to their respective holders. Autodesk reserves the right to alter product and services offerings, and specifications and pricing at any time without notice, and is not responsible for typographical or graphical errors that may appear in this document. © 2016 Autodesk, Inc. All rights reserved.